

LOW DROP FIXED AND ADJUSTABLE POSITIVE VOLTAGE REGULATOR

The KIA1117BS/BF/BPI × × Series are a Low Drop Voltage Regulator able to provide up to 1A of output current, available even in adjustable version (Vref=1.25V)

FEATURES

- Low Dropout Voltage : 1.1V/Typ. (Iout=1.0A)
 - Very Low Quiescent Current : 5mA(Typ)
 - Output Current up to 1A
 - Fixed Output Voltage of 1.2V, 1.5V, 1.8V, 2.5V, 3.3V, 5.0V
 - Adjustable Version Availability : Vref=1.25V
 - Internal Current and Thermal Limit
 - A Minimum of 10μF for stability
 - Suitable for MLCC, Tantalum and Low ESR Electrolytic Capacitors
 - ESR Range for stability : 1m ~200
 - Available in ± 2%(at 25)
 - High Ripple Rejection : 80dB(Typ)
 - Temperature Range : -40 150
 - Suffix U : Qualified to AEC-Q100
- ex) KIA1117BF**-RTF/PU

LINE UP

ITEM	OUTPUT VOLTAGE (V)	PACKAGE
KIA1117BS/BF/BPI00	Adjustable (1.25~10V)	BS : SOT-223 BF : DPAK BPI : TO-220IS
KIA1117BS/BF/BPI12	1.2	
KIA1117BS/BF/BPI15	1.5	
KIA1117BS/BF/BPI18	1.8	
KIA1117BS/BF/BPI25	2.5	
KIA1117BS/BF/BPI33	3.3	
KIA1117BS/BF/BPI50	5.0	

MAXIMUM RATINGS (Ta=25)

CHARACTERISTIC	SYMBOL	RATING	UNIT
Input Voltage	V _{IN}	15	V
Output Current	I _{OUT}	1.0	A
Power Dissipation 1 (No Heatsink)	S (Note)	1.0	W
	F	1.3	
	PI	2.0	
Power Dissipation 2 (Infinite Heatsink)	S	8.3	W
	F	13	
	PI	20.8	
Maximum Junction Temperature	T _{j(max)}	150	
Operating Junction Temperature	T _{opr}	-40 150	
Storage Temperature	T _{stg}	-55 150	

Note) Package Mounted on FR-4 PCB 36mm × 18mm × 1.5mm.
: mounting pad for the GND Lead min. 6mm

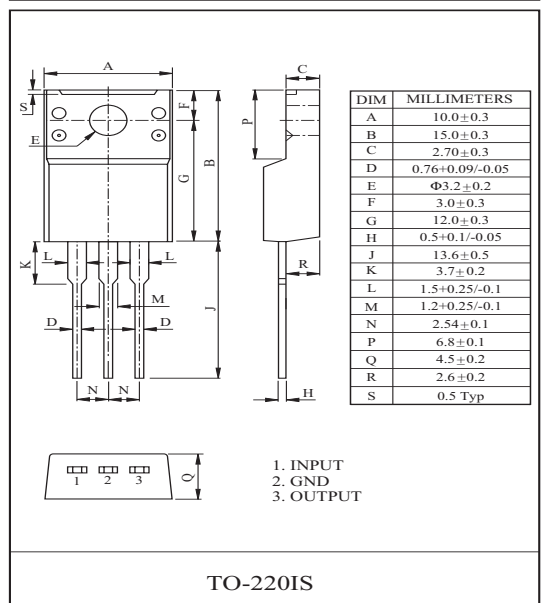
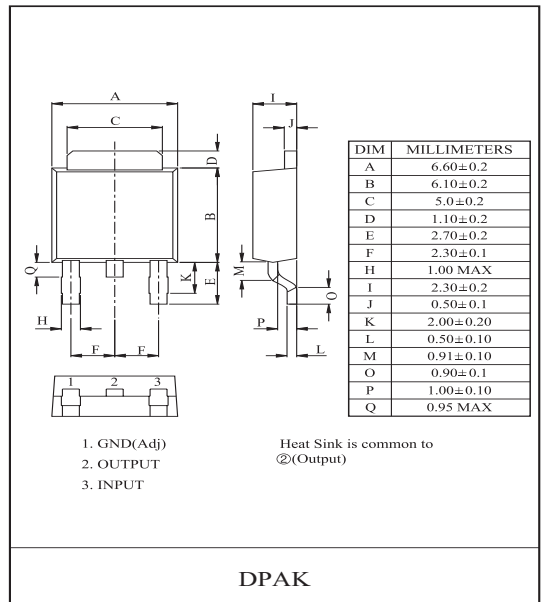
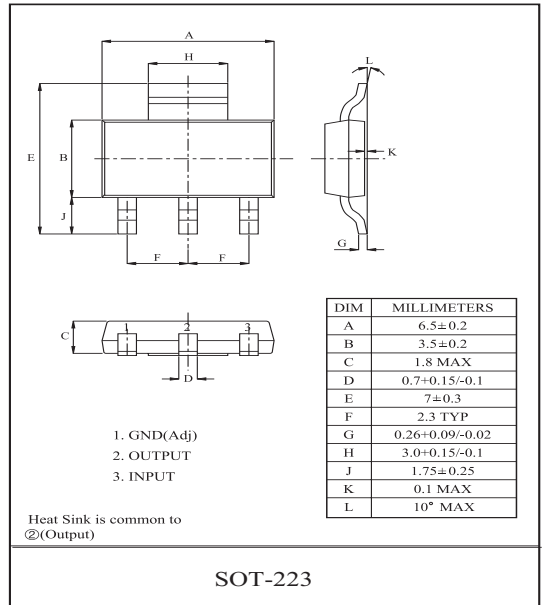

KIA1117BS/BF/BPI00 ~ KIA1117BS/BF/BPI50

ELECTRICAL CHARACTERISTICS

Unless otherwise specified, T_j=25

CHARACTERISTIC	ITEM	SYMBOL	TEST CONDITIONS	MIN.	TYP.	MAX.	UNIT	
Reference Voltage	KIA1117-Adj	V _{REF1}	V _{IN} =V _{OUT} +1.5V, I _{OUT} =10mA	1.225	1.25	1.275	V	
		V _{REF2}	10mA I _{OUT} 1A, V _{OUT} +1.5V V _{IN} =10V	1.213	1.25	1.288	V	
Output Voltage	KIA1117-12	V _{OUT1}	V _{IN} =2.7V, I _{OUT} =10mA	1.176	1.2	1.224	V	
		V _{OUT2}	10mA I _{OUT} 1A, 2.7V V _{IN} 10V	1.164	1.2	1.236	V	
	KIA1117-15	V _{OUT1}	V _{IN} =3.0V, I _{OUT} =10mA	1.470	1.5	1.530	V	
		V _{OUT2}	10mA I _{OUT} 1A, 3.0V V _{IN} 10V	1.460	1.5	1.540	V	
	KIA1117-18	V _{OUT1}	V _{IN} =3.3V, I _{OUT} =10mA	1.764	1.8	1.836	V	
		V _{OUT2}	10mA I _{OUT} 1A, 3.3V V _{IN} 10V	1.754	1.8	1.846	V	
	KIA1117-25	V _{OUT1}	V _{IN} =4.0V, I _{OUT} =10mA	2.450	2.5	2.550	V	
		V _{OUT2}	10mA I _{OUT} 1A, 4.0V V _{IN} 10V	2.440	2.5	2.560	V	
	KIA1117-33	V _{OUT1}	V _{IN} =4.8V, I _{OUT} =10mA	3.234	3.3	3.366	V	
		V _{OUT2}	10mA I _{OUT} 1A, 4.8V V _{IN} 10V	3.201	3.3	3.399	V	
	KIA1117-50	V _{OUT1}	V _{IN} =6.5V, I _{OUT} =10mA	4.900	5.0	5.100	V	
		V _{OUT2}	10mA I _{OUT} 1A, 6.5V V _{IN} 10V	4.850	5.0	5.150	V	
	Line Regulation	-	Reg Line	V _{OUT} +1.5V V _{IN} 10V, I _{OUT} =10mA	-	1	10	mV
	Load Regulation	-	Reg Load	10mA I _{OUT} 1A, V _{IN} =V _{OUT} +2.0V	-	0.5	1	%
	Adjustable Pin Current	KIA1117-Adj	I _{ADJ}	V _{IN} =V _{OUT} +1.5V	-	35	-	μA
	Minimum Load Current	KIA1117-Adj	I _{MIN}	V _{IN} =V _{OUT} +1.5V	10	-	-	mA
Quiescent Current	-	I _{B1}	V _{IN} =V _{OUT} +1.25V, I _{OUT} =0A	-	5	10	mA	
		I _{B2}	V _{IN} =10V, I _{OUT} =0A	-	5	10		
Output Noise Voltage	-	V _{NO}	V _{IN} =V _{OUT} +1.25V, I _{OUT} =40mA, 10Hz f 10kHz	-	100	-	μV _{rms}	
Short Circuit Current Limit	-	I _{SC}	V _{IN} =V _{OUT} +2.0V	1.1	-	-	A	
Ripple Rejection	-	R · R	I _{OUT} =40mA, f=120Hz, V _{ripple} =1Vp-p V _{IN} =V _{OUT} +3V	60	80	-	dB	
Dropout Voltage	-	V _D	I _{OUT} =1A	-	1.1	1.4	V	
Temperature Stability	-	TCV _O	V _{IN} =V _{OUT} +1.5V, I _{OUT} =10mA, T _j =-40~150	-	0.5	-	%	

KIA1117BS/BF/BPI00 ~ KIA1117BS/BF/BPI50

Fig.1 Application Circuit-1 (Fixed-Type)

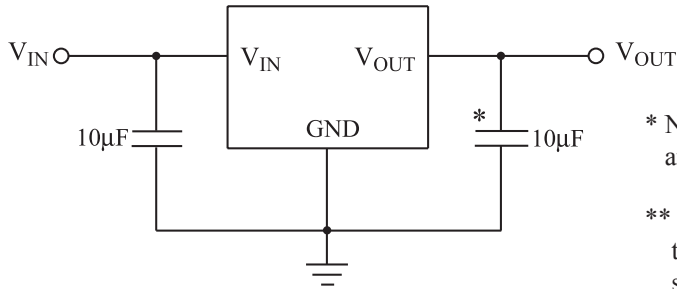

* Note 1) MLCC, Tantalum, Low ESR Electrolytic Capacitors are suitable in ESR range for stability (1m~200)

** Note 2) When R1 is much larger than 124 , apply 8~10mA to Vout-GND by setting an additional dummy resistor for stability of Vout under no load condition

Fig.2 Application Circuit-2 (Adjustable-Type)

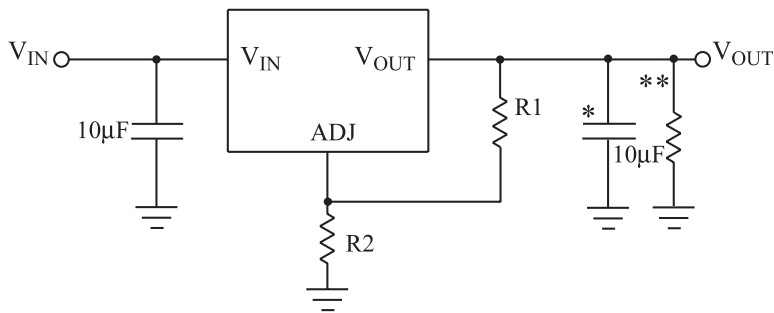

$$V_{OUT} = V_{REF} \times (1 + R2/R1) + I_{ADJ} \times R2$$

KIA1117BS/BF/BPI00 ~ KIA1117BS/BF/BPI50

Fig. 3 $V_D - I_{OUT}$

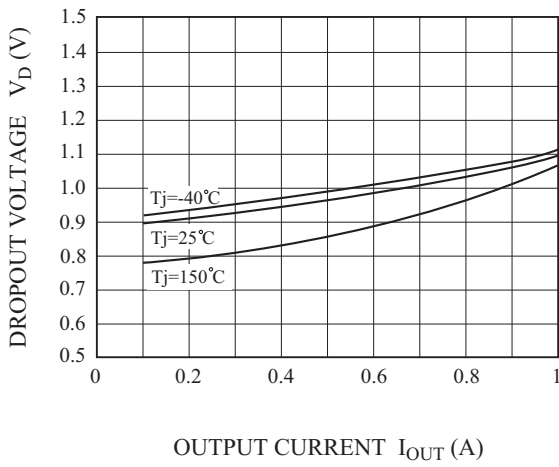

Fig. 4 $V_{OUT}(\text{CHANGE}) - T_j$

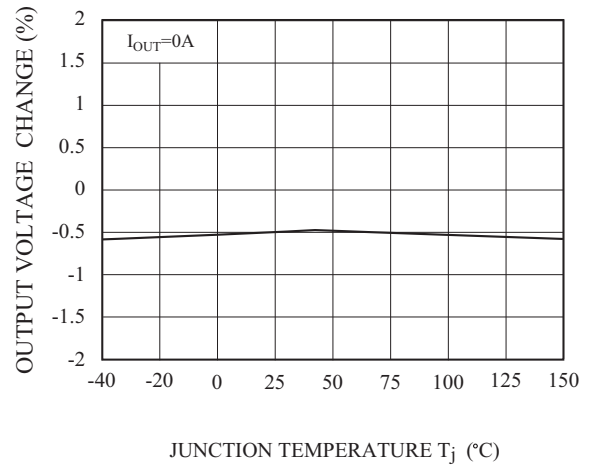

Fig. 5 LINE REGULATION

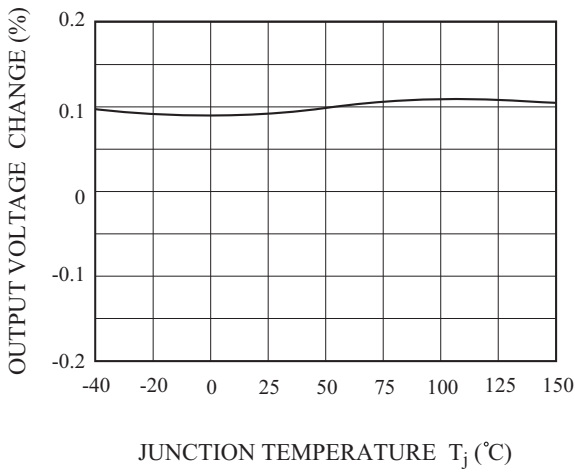

Fig. 6 LOAD REGULATION

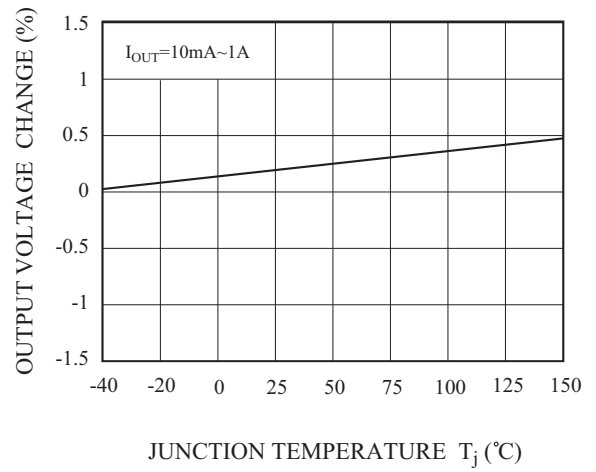

Fig.7 $I_Q - T_j$

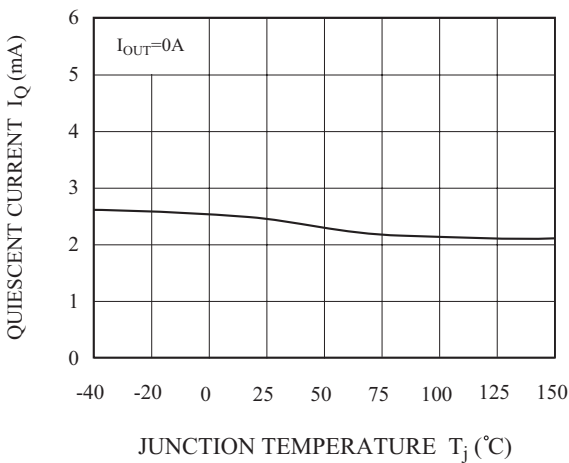
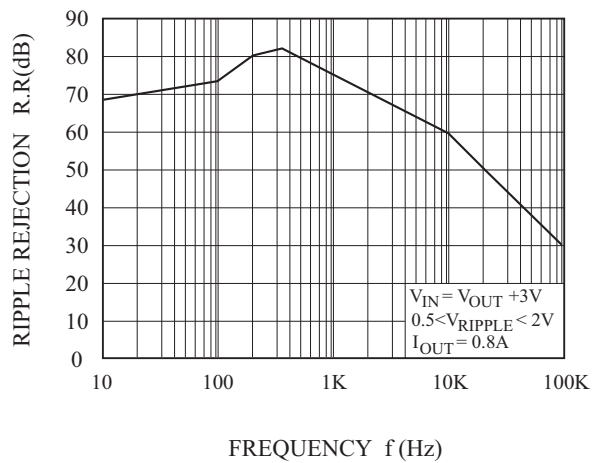

Fig.8 R.R - f



KIA1117BS/BF/BPI00 ~ KIA1117BS/BF/BPI50

Fig.9 $P_D - T_a$ (S-Type : SOT-223)

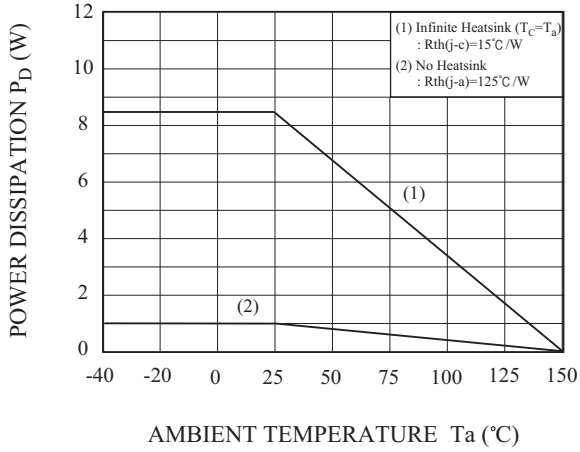

Fig.10 $P_D - T_a$ (F-Type : DPAK)

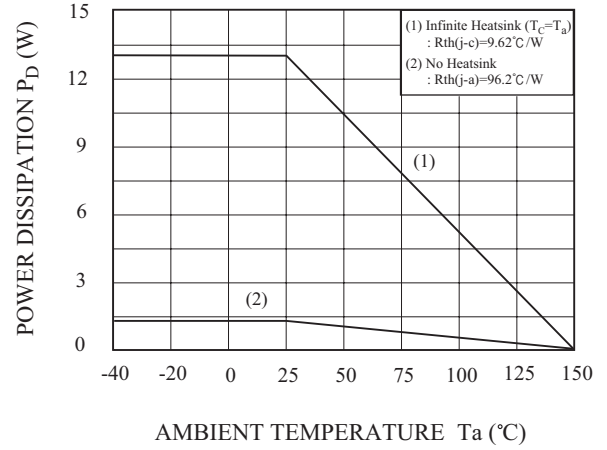

Fig. 11 $P_D - T_a$ (API-Type : TO-220IS)

