

# General Purpose Transistors

## NPN Silicon

We declare that the material of product compliance with RoHS requirements.

S- Prefix for Automotive and Other Applications Requiring Unique Site and Control Change Requirements; AEC-Q101 Qualified and PPAP Capable.

### ORDERING INFORMATION (Pb-Free)

Device	Package	Shipping
LBC846AWT1G S-LBC846AWT1G	SC-70	3000/Tape&Reel
LBC846AWT3G S-LBC846AWT3G	SC-70	10000/Tape&Reel

### MAXIMUM RATINGS

Rating	Symbol	BC846	BC847	BC848	Unit
Collector-Emitter Voltage	$V_{CEO}$	65	45	30	V
Collector-Base Voltage	$V_{CBO}$	80	50	30	V
Emitter-Base Voltage	$V_{EBO}$	6.0	6.0	5.0	V
Collector Current — Continuous	$I_C$	100	100	100	mAdc

### THERMAL CHARACTERISTICS

Characteristic	Symbol	Max	Unit
Total Device Dissipation	$P_D$	150	mW
Thermal Resistance, Junction to Ambient	$R_{\theta JA}$	833	°C/W
Junction and Storage Temperature	$T_J, T_{stg}$	-55 to +150	°C

### DEVICE MARKING

LBC846AWT1G = 1A; LBC846BWT1G = 1B; LBC847AWT1G = 1E; LBC847BWT1G = 1F;  
LBC847CWT1G = 1G; LBC848AWT1G = 1J; LBC848BWT1G = 1K; LBC848CWT1G = 1L;

### ELECTRICAL CHARACTERISTICS ( $T_A = 25^\circ\text{C}$ unless otherwise noted.)

Characteristic	Symbol	Min	Typ	Max	Unit
----------------	--------	-----	-----	-----	------

#### OFF CHARACTERISTICS

Collector-Emitter Breakdown Voltage ( $I_C = 10\text{ mA}$ )	LBC846 Series	65	—	—	v
	LBC847 Series	45	—	—	
	LBC848 Series	30	—	—	
Collector-Emitter Breakdown Voltage ( $I_C = 10\ \mu\text{A}, V_{EB} = 0$ )	LBC846 Series	80	—	—	v
	LBC847 Series	50	—	—	
	LBC848 Series	30	—	—	
Collector-Base Breakdown Voltage ( $I_C = 10\ \mu\text{A}$ )	LBC846 Series	80	—	—	v
	LBC847 Series	50	—	—	
	LBC848 Series	30	—	—	
Emitter-Base Breakdown Voltage ( $I_E = 1.0\ \mu\text{A}$ )	LBC846 Series	6.0	—	—	v
	LBC847 Series	6.0	—	—	
	LBC848 Series	5.0	—	—	
Collector Cutoff Current ( $V_{CB} = 30\text{ V}$ ) ( $V_{CB} = 30\text{ V}, T_A = 150^\circ\text{C}$ )		$I_{CBO}$	—	—	15 nA
			—	—	5.0 $\mu\text{A}$

1.FR-5=1.0 x 0.75 x 0.062in

LBC846AWT1G,BWT1G  
LBC847AWT1G,BWT1G  
CWT1G  
LBC848AWT1G,BWT1G  
CWT1G  
S-LBC846AWT1G,BWT1G  
S-LBC847AWT1G,BWT1G  
CWT1G  
S-LBC848AWT1G,BWT1G  
CWT1G

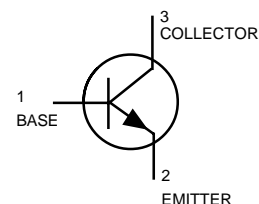
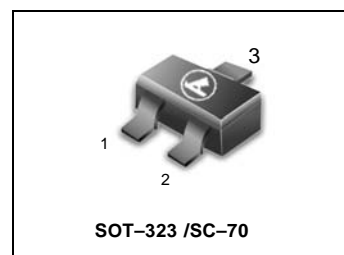

**LBC846AWT1G,BWT1G, LBC847AWT1G,BWT1G, CWT1G, LBC848AWT1G,BWT1G,CWT1G  
S-LBC846AWT1G,BWT1G, S-LBC847AWT1G,BWT1G, CWT1G, S-LBC848AWT1G,BWT1G,CWT1G**

**ELECTRICAL CHARACTERISTICS**( $T_A = 25^\circ\text{C}$  unless otherwise noted) (Continued)

Characteristic	Symbol	Min	Typ	Max	Unit
<b>ON CHARACTERISTICS</b>					
DC Current Gain ( $I_C = 2.0\text{ mA}, V_{CE} = 5.0\text{ V}$ )	$h_{FE}$				
LBC846A, LBC847A, LBC848A		110	180	220	
LBC846B, LBC847B, LBC848B		200	290	450	
LBC847C, LBC848C		420	520	800	
Collector–Emitter Saturation Voltage ( $I_C = 10\text{ mA}, I_B = 0.5\text{ mA}$ ) ( $I_C = 100\text{ mA}, I_B = 5.0\text{ mA}$ )	$V_{CE(sat)}$	—	—	0.25 0.6	V
Base–Emitter Saturation Voltage ( $I_C = 10\text{ mA}, I_B = 0.5\text{ mA}$ ) ( $I_C = 100\text{ mA}, I_B = 5.0\text{ mA}$ )	$V_{BE(sat)}$	—	0.7 0.9	—	V
Base–Emitter Voltage ( $I_C = 2.0\text{ mA}, V_{CE} = 5.0\text{ V}$ ) ( $I_C = 10\text{ mA}, V_{CE} = 5.0\text{ V}$ )	$V_{BE(on)}$	580	660	700 770	mV

**SMALL–SIGNAL CHARACTERISTICS**

Current–Gain — Bandwidth Product ( $I_C = 10\text{ mA}, V_{CE} = 5.0\text{ Vdc}, f = 100\text{ MHz}$ )	$f_T$	100	—	—	MHz
Output Capacitance ( $V_{CB} = 10\text{ V}, f = 1.0\text{ MHz}$ )	$C_{obo}$	—	—	4.5	pF
Noise Figure ( $I_C = 0.2\text{ mA}, V_{CE} = 5.0\text{ Vdc}, R_S = 2.0\text{ k}\Omega, f = 1.0\text{ kHz}, BW = 200\text{ Hz}$ )	NF	—	—	10 4.0	dB

**LBC846A, LBC847A, LBC848A**

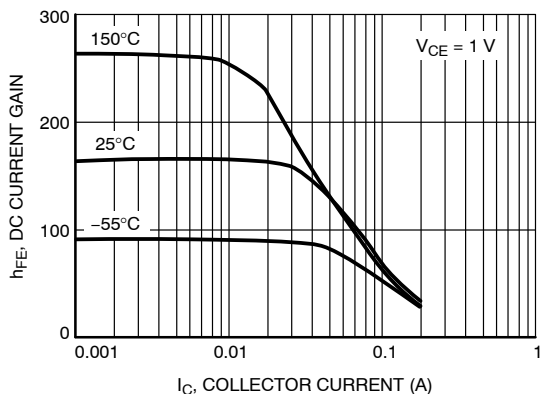

**Figure 1. DC Current Gain vs. Collector Current**

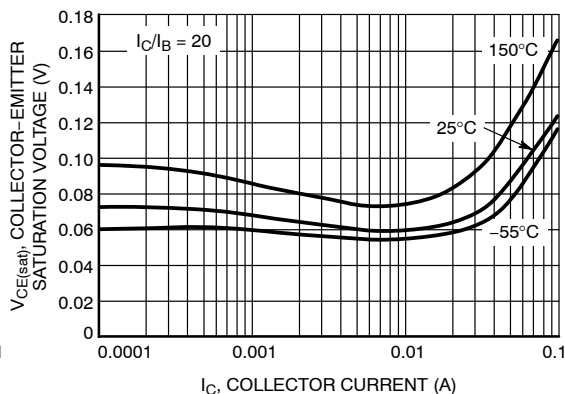

**Figure 2. Collector Emitter Saturation Voltage vs. Collector Current**

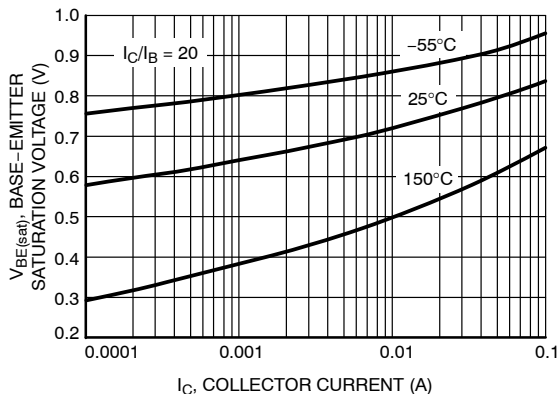

**Figure 3. Base Emitter Saturation Voltage vs. Collector Current**

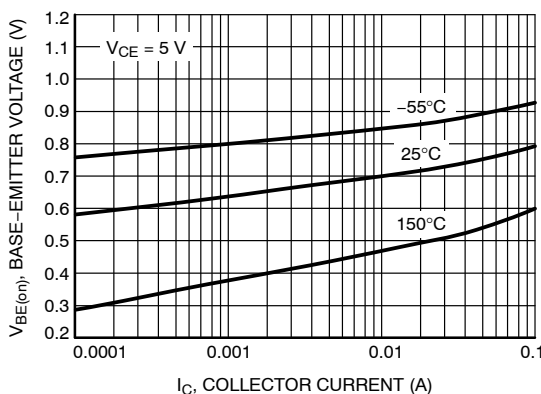

**Figure 4. Base Emitter Voltage vs. Collector Current**

LBC846AWT1G, BWT1G, LBC847AWT1G, BWT1G, CWT1G, LBC848AWT1G, BWT1G, CWT1G  
 S-LBC846AWT1G, BWT1G, S-LBC847AWT1G, BWT1G, CWT1G, S-LBC848AWT1G, BWT1G, CWT1G

LBC846A, LBC847A, LBC848A

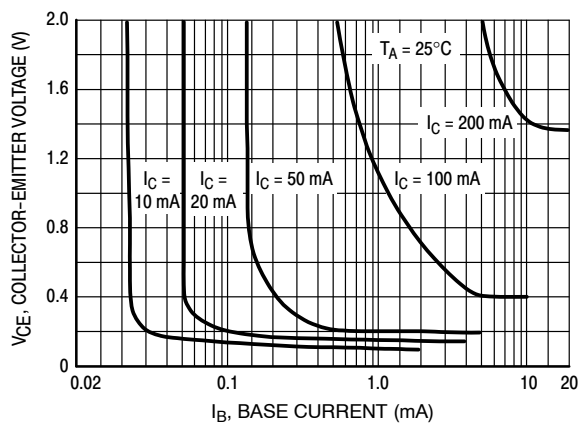

Figure 5. Collector Saturation Region

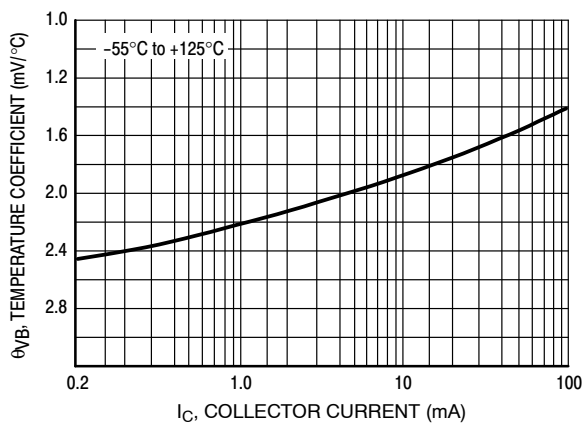

Figure 6. Base-Emitter Temperature Coefficient

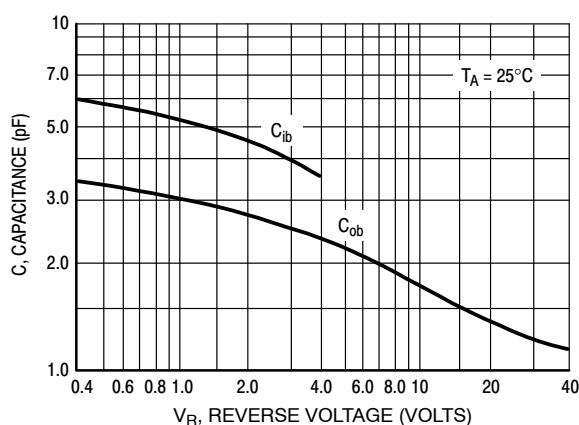

Figure 7. Capacitances

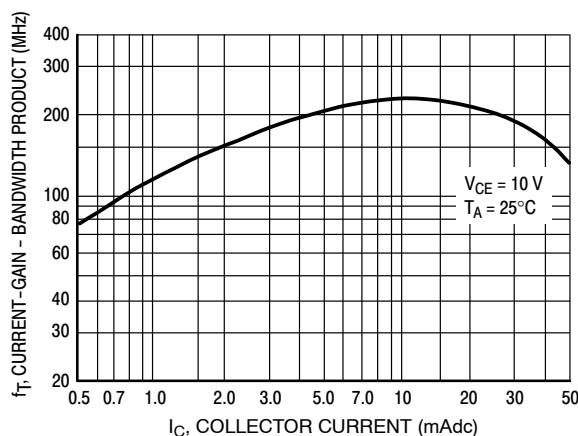

Figure 8. Current-Gain - Bandwidth Product

LBC846B

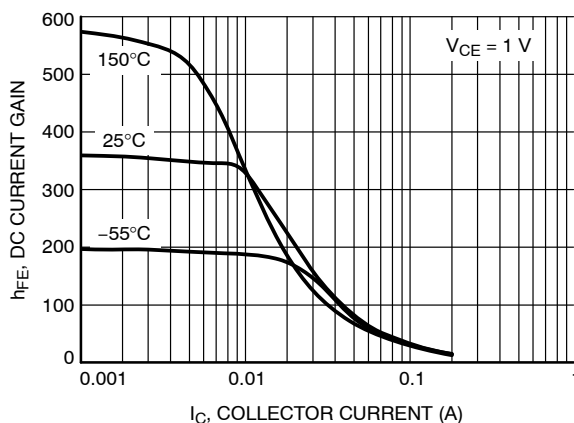

Figure 9. DC Current Gain vs. Collector Current

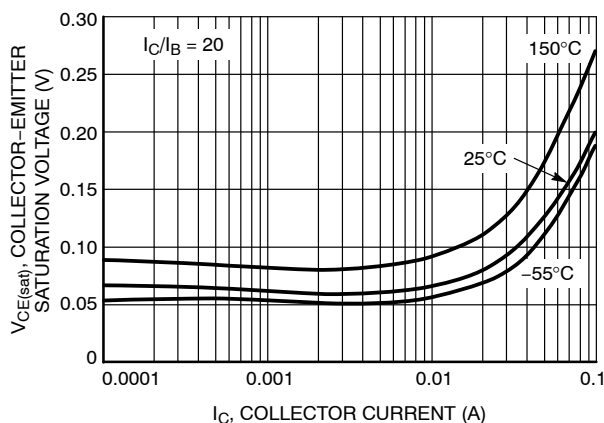

Figure 10. Collector Emitter Saturation Voltage vs. Collector Current

LBC846AWT1G, BWT1G, LBC847AWT1G, BWT1G, CWT1G, LBC848AWT1G, BWT1G, CWT1G  
 S-LBC846AWT1G, BWT1G, S-LBC847AWT1G, BWT1G, CWT1G, S-LBC848AWT1G, BWT1G, CWT1G

LBC846B

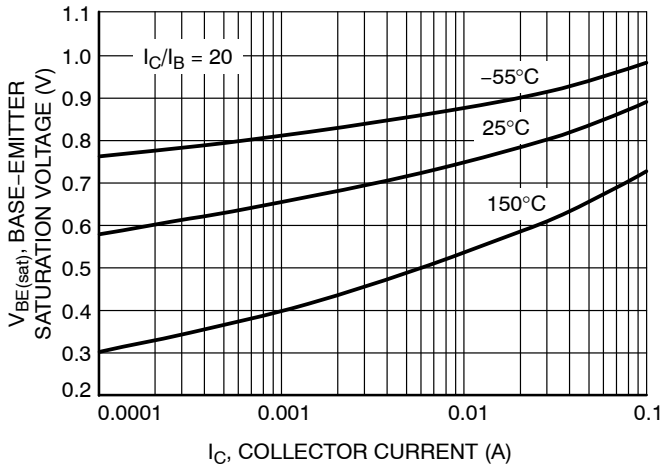

Figure 11. Base Emitter Saturation Voltage vs. Collector Current

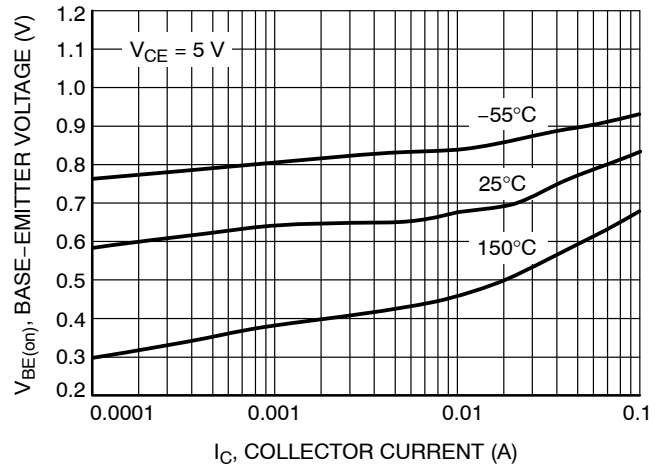

Figure 12. Base Emitter Voltage vs. Collector Current

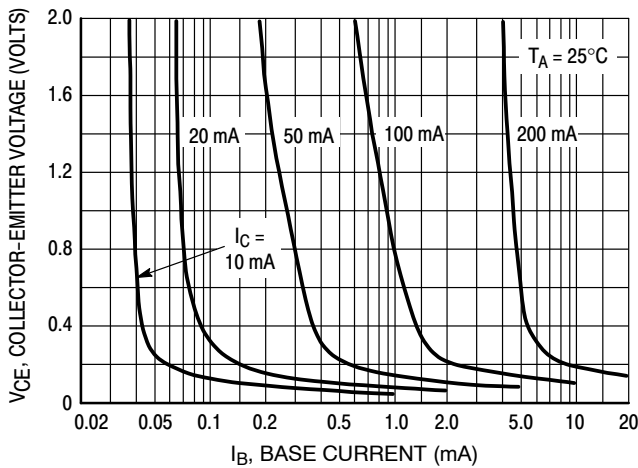

Figure 13. Collector Saturation Region

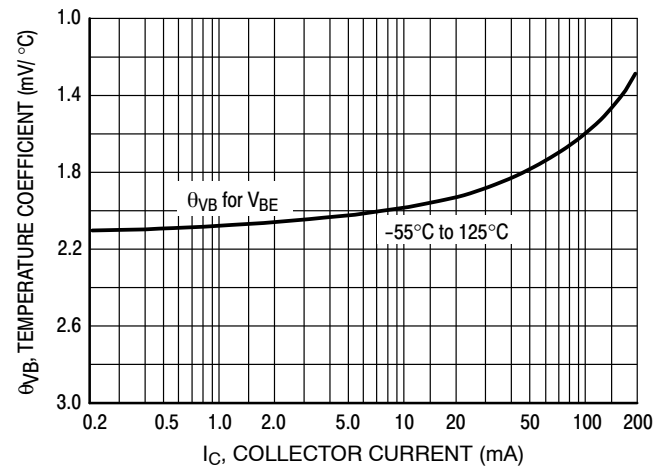

Figure 14. Base-Emitter Temperature Coefficient

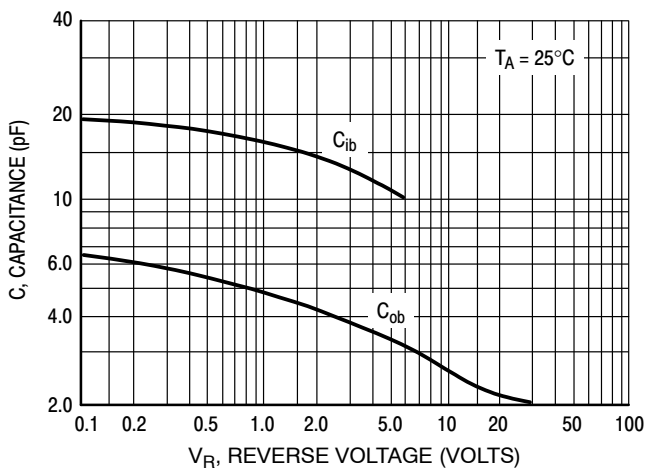

Figure 15. Capacitance

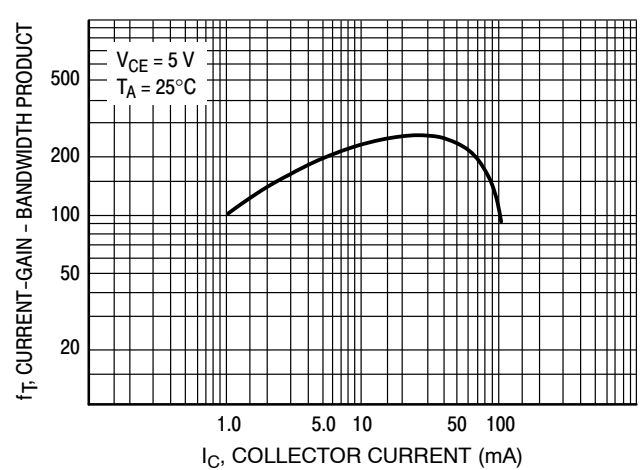

Figure 16. Current-Gain - Bandwidth Product

LBC846AWT1G, BWT1G, LBC847AWT1G, BWT1G, CWT1G, LBC848AWT1G, BWT1G, CWT1G  
 S-LBC846AWT1G, BWT1G, S-LBC847AWT1G, BWT1G, CWT1G, S-LBC848AWT1G, BWT1G, CWT1G  
 LBC847B, LBC848B

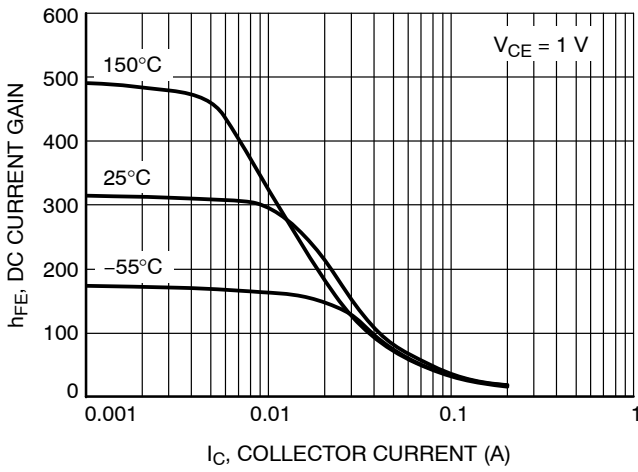

Figure 17. DC Current Gain vs. Collector Current

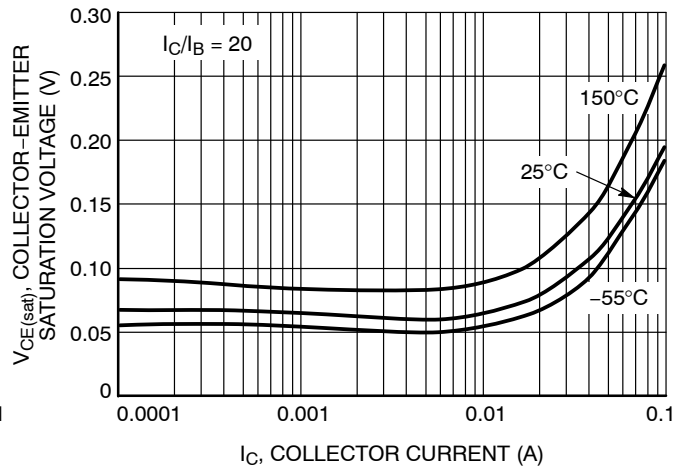

Figure 18. Collector Emitter Saturation Voltage vs. Collector Current

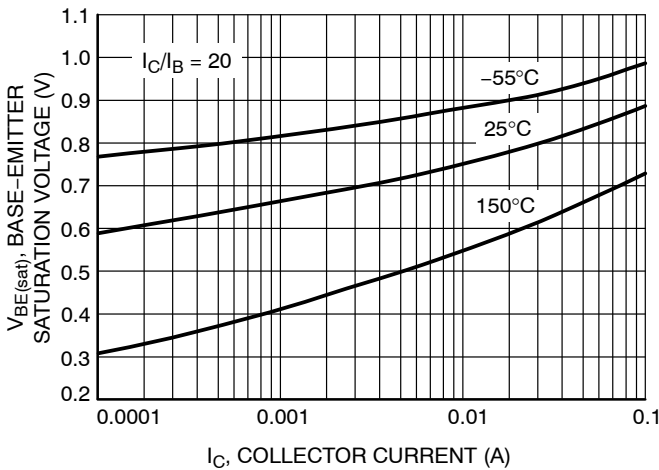

Figure 19. Base Emitter Saturation Voltage vs. Collector Current

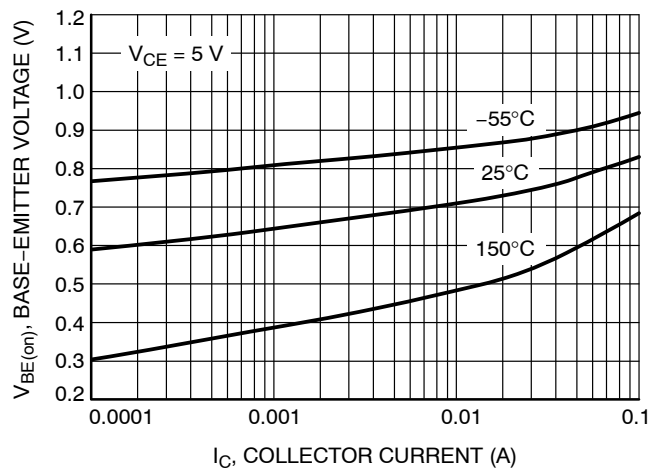

Figure 20. Base Emitter Voltage vs. Collector Current

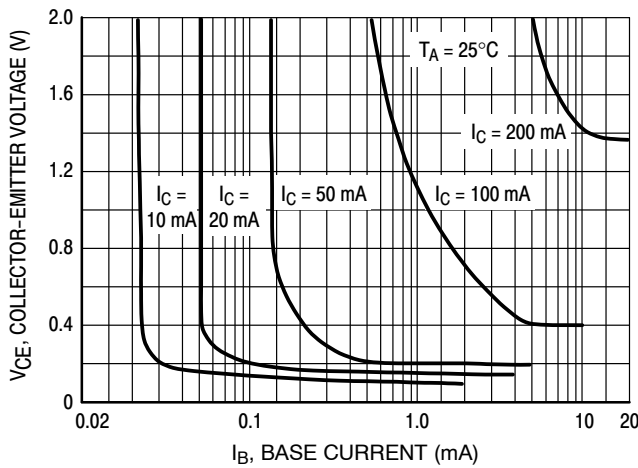

Figure 21. Collector Saturation Region

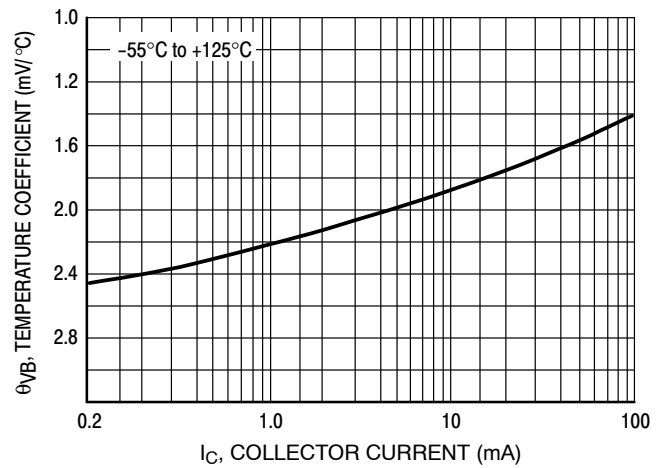

Figure 22. Base-Emitter Temperature Coefficient

LBC846AWT1G, BWT1G, LBC847AWT1G, BWT1G, CWT1G, LBC848AWT1G, BWT1G, CWT1G  
 S-LBC846AWT1G, BWT1G, S-LBC847AWT1G, BWT1G, CWT1G, S-LBC848AWT1G, BWT1G, CWT1G  
 LBC847B, LBC848B

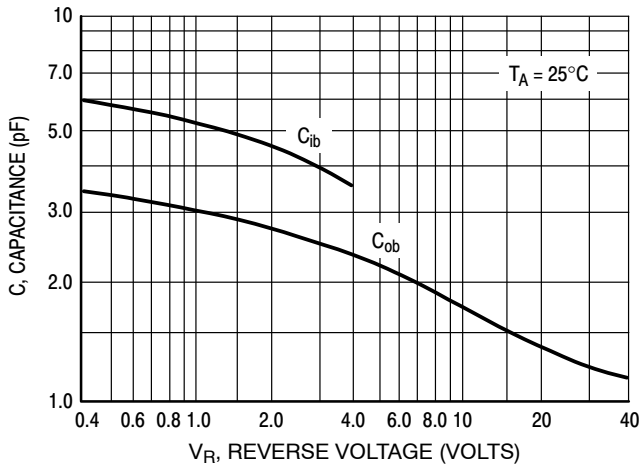

Figure 23. Capacitances

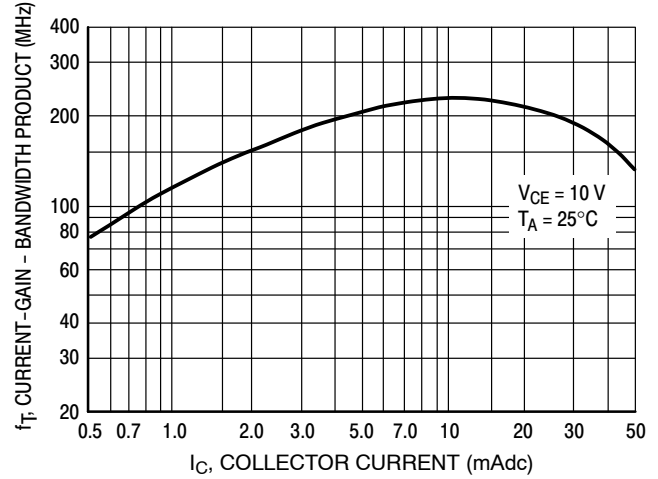

Figure 24. Current-Gain - Bandwidth Product

LBC847C, LBC848C, LBC849C, LBC850C

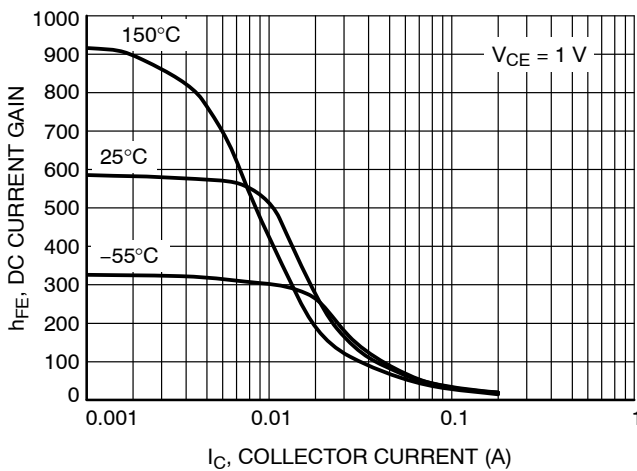

Figure 25. DC Current Gain vs. Collector Current

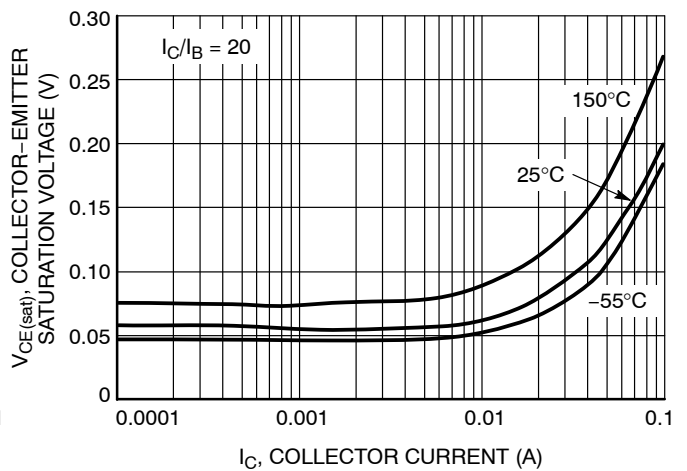

Figure 26. Collector Emitter Saturation Voltage vs. Collector Current

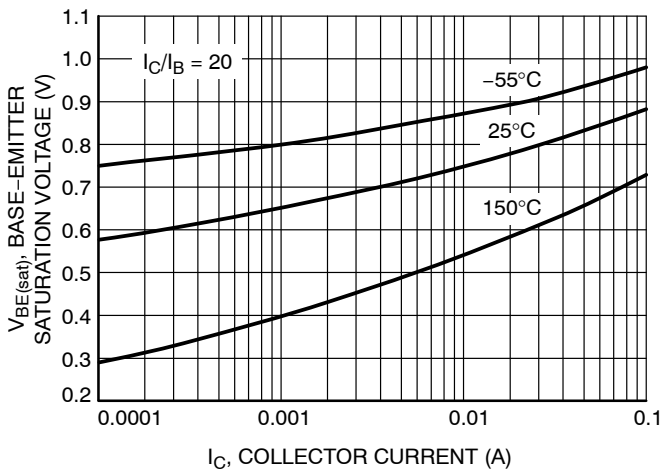

Figure 27. Base Emitter Saturation Voltage vs. Collector Current

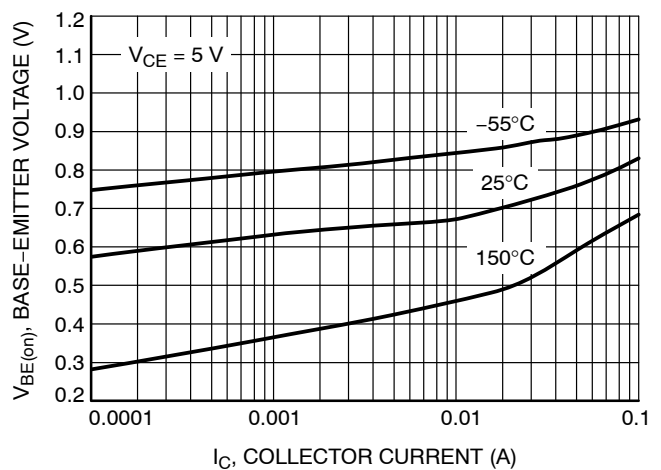

Figure 28. Base Emitter Voltage vs. Collector Current

LBC846AWT1G, BWT1G, LBC847AWT1G, BWT1G, CWT1G, LBC848AWT1G, BWT1G, CWT1G  
 S-LBC846AWT1G, BWT1G, S-LBC847AWT1G, BWT1G, CWT1G, S-LBC848AWT1G, BWT1G, CWT1G

LBC847C, LBC848C

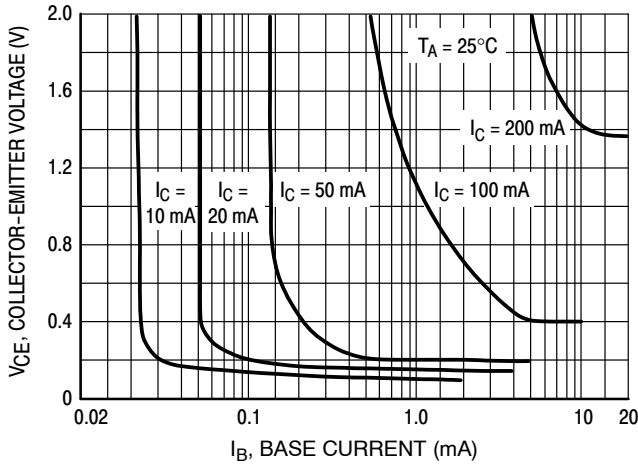

Figure 29. Collector Saturation Region

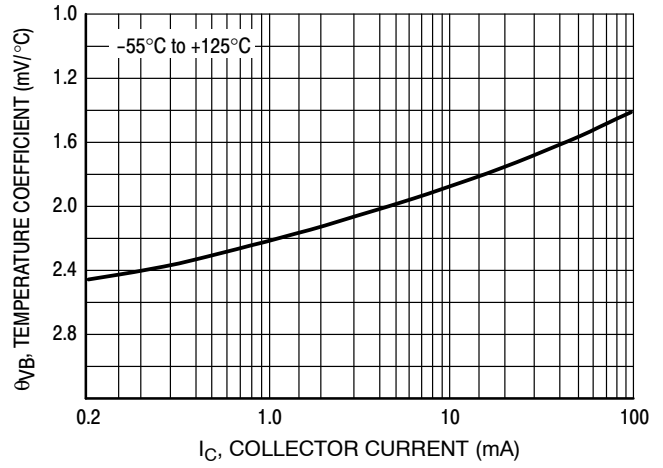

Figure 30. Base-Emitter Temperature Coefficient

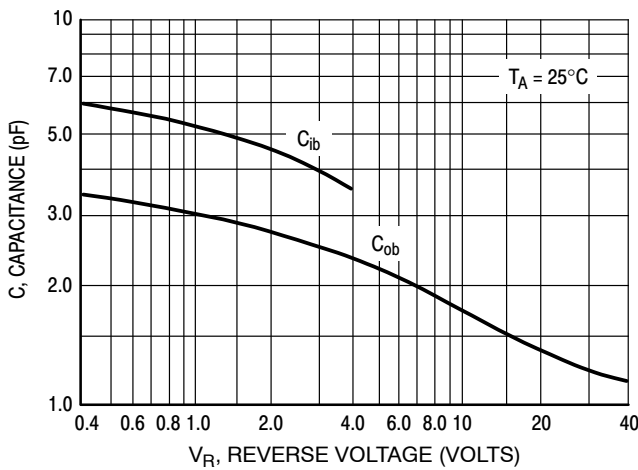

Figure 31. Capacitances

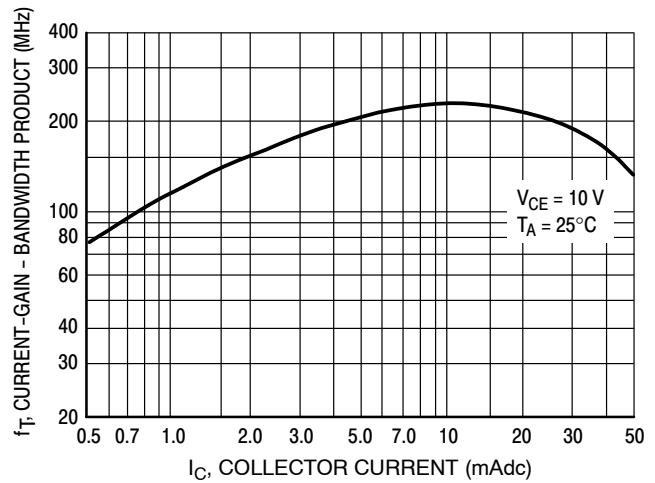
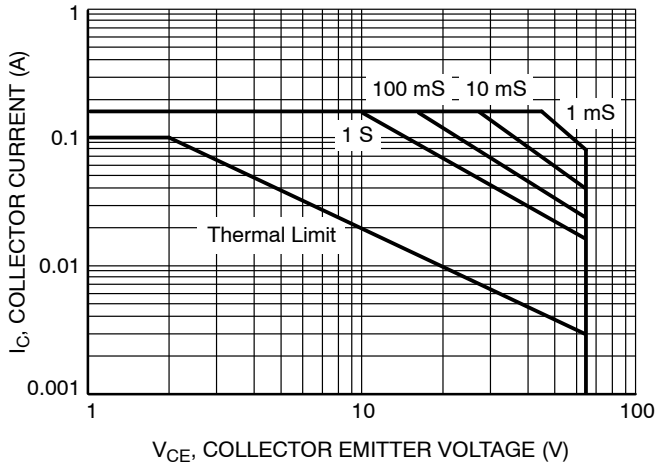
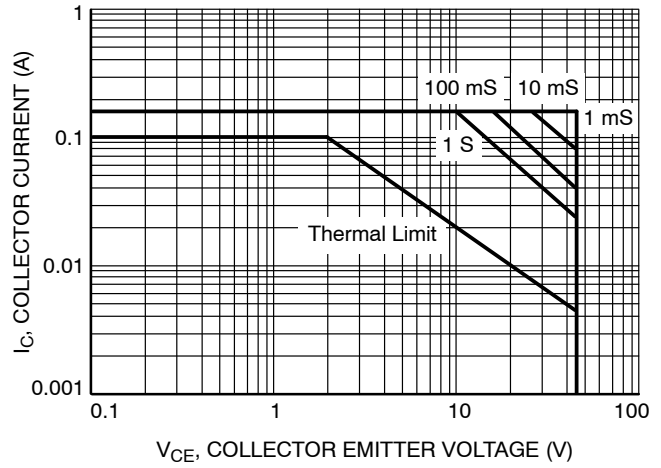

Figure 32. Current-Gain - Bandwidth Product

LBC846AWT1G,BWT1G, LBC847AWT1G,BWT1G, CWT1G, LBC848AWT1G,BWT1G,CWT1G  
 S-LBC846AWT1G,BWT1G, S-LBC847AWT1G,BWT1G, CWT1G, S-LBC848AWT1G,BWT1G,CWT1G



**Figure 33. Safe Operating Area for LBC846A, LBC846B**



**Figure 34. Safe Operating Area for LBC847A, LBC847B, LBC847C**

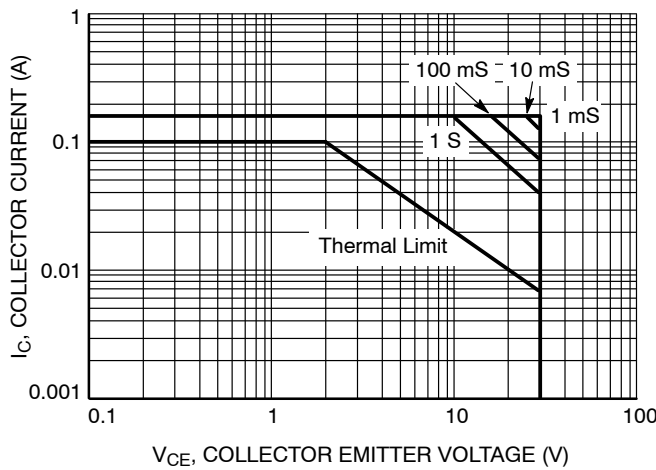
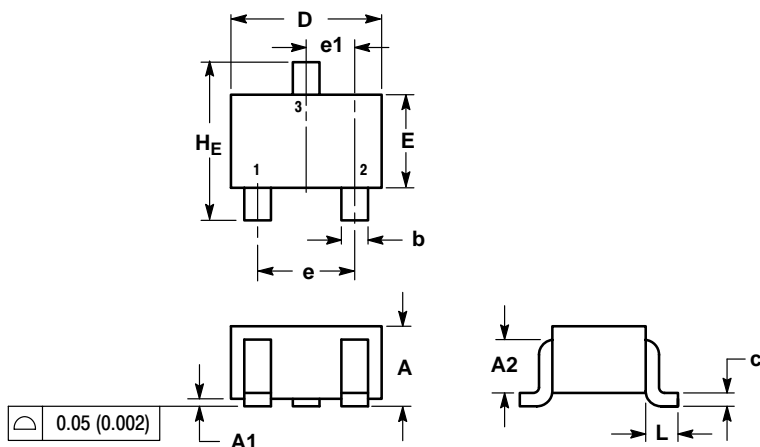

**Figure 35. Safe Operating Area for LBC848A, LBC848B, LBC848C**



LBC846AWT1G, BWT1G, LBC847AWT1G, BWT1G, CWT1G, LBC848AWT1G, BWT1G, CWT1G  
 S-LBC846AWT1G, BWT1G, S-LBC847AWT1G, BWT1G, CWT1G, S-LBC848AWT1G, BWT1G, CWT1G

SC-70 / SOT-323



NOTES:  
 1. DIMENSIONING AND TOLERANCING PER ANSI Y14.5M, 1982.  
 2. CONTROLLING DIMENSION: INCH.

DIM	MILLIMETERS			INCHES		
	MIN	NOM	MAX	MIN	NOM	MAX
A	0.80	0.90	1.00	0.032	0.035	0.040
A1	0.00	0.05	0.10	0.000	0.002	0.004
A2	0.7 REF			0.028 REF		
b	0.30	0.35	0.40	0.012	0.014	0.016
c	0.10	0.18	0.25	0.004	0.007	0.010
D	1.80	2.10	2.20	0.071	0.083	0.087
E	1.15	1.24	1.35	0.045	0.049	0.053
e	1.20	1.30	1.40	0.047	0.051	0.055
e1	0.65 BSC			0.026 BSC		
L	0.425 REF			0.017 REF		
He	2.00	2.10	2.40	0.079	0.083	0.095

GENERIC MARKING DIAGRAM

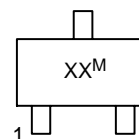

XX = Specific Device Code  
 M = Date Code  
 ■ = Pb-Free Package

\*This information is generic. Please refer to device data sheet for actual part marking. Pb-Free indicator, "G" or microdot "■", may or may not be present.

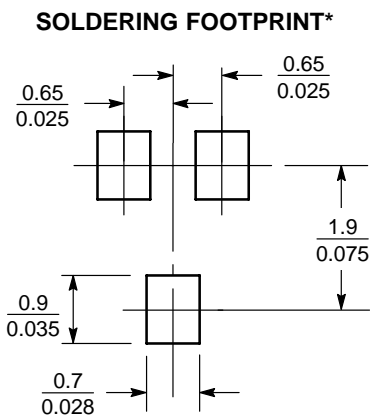

SCALE 10:1 (mm/inches)