

1A Bipolar Linear Regulator

LR1117D

DESCRIPTION

LR1117D is a series of low dropout three-terminal regulators with a dropout of 1.3V at 1A load current. LR1117D features a very low standby current 2mA compared to 5mA of competitor.

Other than a fixed version, $V_{out} = 1.2V, 1.5V, 1.8V, 2.5V, 2.85V, 3.3V, 5V$, LR1117D has an adjustable version, which can provide an output voltage from 1.25V to 12V with only two external resistors.

LR1117D offers thermal shut down functions, to assure the stability of chip and power system. And it uses trimming technique to guarantee output voltage accuracy within $\pm 2\%$. Other output voltage accuracy can be customized on demand, such as $\pm 1\%$

LR1117D is available in SOT-223, TO-252 power package.

FEATURES

- Other than a fixed version and an adjustable version, output value can be customized on demand.
- Output current : 1.0A
- Range of operation input voltage: Max 15V
- Standby current: 2mA (typ.)
- Line regulation: 0.03%/V (typ.)
- Load regulation: 0.2%/A (typ.)
- Environment Temperature: $-40^{\circ}C \sim 85^{\circ}C$

APPLICATIONS

- Power Management for Computer Mother Board, Graphic Card
- BLD Monitor and BLD TV
- DVD Decode Board
- ADSL Modem
- Post Regulators for Switching Supplies

TYPICAL APPLICATION

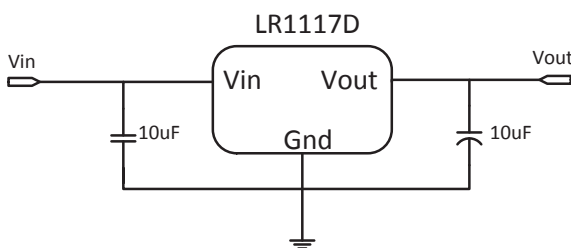

Application circuit of LR1117D fixed version

NOTE: Input capacitor ($C_{in}=10\mu F$) and Output capacitor ($C_{out}=10\mu F$) are recommended in all application circuit. Tantalum capacitor is recommended.

TYPICAL ELECTRICAL CHARACTERISTIC

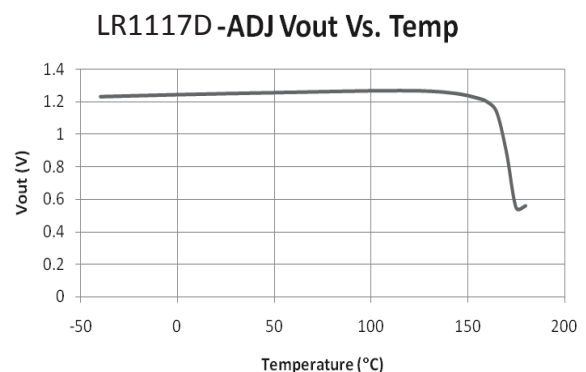

ORDERING INFORMATION

PIN CONFIGURATION AND MARKING

LR1117DX XX X

Rohs Std.
X: Pb-free Rohs Std, Output voltage accuracy within $\pm 2\%$

Output Voltage:

12.....1.2V
15.....1.5V
18.....1.8V
25.....2.5V
28.....2.85V
33.....3.3V
50.....5.0V
.....ADJ

Package Type:

S: SOT-223
D: TO-252

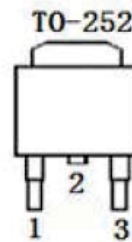
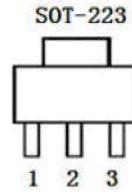

Pin Description:

Fixed Version

Pin No.	Symbol	Definition
1	Gnd	Ground
2	Vout	Output
3	Vin	Input

Adjustable Version

Pin No.	Symbol	Definition
1	Adj.	Adjustable
2	Vout	Output
3	Vin	Input

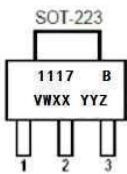

Marking	Designator	Description
1117 B VWXX YYZ	1117 B	Product code
	V W	assemble year and week
	XX	Manufacture Lot No. (the end two number)
	YY	Output Voltage
	Z	Version please fixed

ABSOLUTE MAXIMUM RATING

Parameter	Value	
Max Input Voltage	18V ^①	
Max Operating Junction Temperature(Tj)	150°C	
Package Thermal Resistance	SOT-223	20°C / W
	TO-252	10°C / W
Storage Temperature(Ts)	-40°C - 150°C	
Lead Temperature & Time	260°C, 10s	

Note: Exceed these limits to damage to the device. Exposure to absolute maximum rating conditions may affect device reliability.

RECOMMENDED WORK CONDITIONS

Parameter	Value
Input Voltage Range	Max. 15V
Operating Junction Temperature(Tj)	-40°C -125°C

ELECTRICAL CHARACTERISTICS

Tj=25°C

Symbol	Parameter	Conditions	Min	Typ	Max	Unit
Vref	Reference Voltage	LR1117D-ADJ 10mA ≤ Iout ≤ 1A, Vin = 3.25V	1.225	1.25	1.275	V
Vout	Output Voltage	LR1117D-1.2V 0 ≤ Iout ≤ 1A, Vin = 3.2V	1.164	1.2	1.224	V
		LR1117-1.5V 0 ≤ Iout ≤ 1A, Vin = 3.5V	1.47	1.5	1.53	V
		LR1117D-1.8V 0 ≤ Iout ≤ 1A, Vin = 3.8V	1.764	1.8	1.836	V
		LR1117D-2.5V 0 ≤ Iout ≤ 1A, Vin = 4.5V	2.45	2.5	2.55	V
		LR1117D-2.85V 0 ≤ Iout ≤ 1A, Vin = 4.85V	2.793	2.85	2.907	V
		LR1117D-3.3V 0 ≤ Iout ≤ 1A, Vin = 5.3V	3.234	3.3	3.366	V
		LR1117D-5.0V 0 ≤ Iout ≤ 1A, Vin = 7.0V	4.9	5	5.1	V
		ΔVout	Line Regulation	LR1117D-ADJ Iout = 10mA, 2.75V ≤ Vin ≤ 12V		0.03
LR1117D-1.2V Iout = 10mA, 2.7V ≤ Vin ≤ 10V				0.03	0.2	%/V
LR1117-1.5V Iout = 10mA, 3.0V ≤ Vin ≤ 12V				0.03	0.2	%/V
LR1117D-1.8V Iout = 10mA, 3.0V ≤ Vin ≤ 12V				0.03	0.2	%/V
LR1117D-2.5V Iout = 10mA, 3.3V ≤ Vin ≤ 12V				0.03	0.2	%/V
LR1117D-2.85V Iout = 10mA, 4.0V ≤ Vin ≤ 12V				0.03	0.2	%/V
LR1117D-3.3V Iout = 10mA, 4.8V ≤ Vin ≤ 12V				0.03	0.2	%/V
LR1117D-5.0V Iout = 10mA, 6.5V ≤ Vin ≤ 12V				0.03	0.2	%/V
ΔVout	Load Regulation	LR1117D-ADJ Vin = 2.75V, 10mA ≤ Iout ≤ 1A		2	8	mV
		LR1117D-1.2V Vin = 2.7V, 10mA ≤ Iout ≤ 1A		2	8	mV
		LR1117-1.5V Vin = 3.0V, 10mA ≤ Iout ≤ 1A		2	10	mV
		LR1117D-1.8V Vin = 3.3V, 10mA ≤ Iout ≤ 1A		3	12	mV
		LR1117D-2.5V Vin = 3.8V, 10mA ≤ Iout ≤ 1A		4	16	mV
		LR1117D-2.85V Vin = 4.35V, 10mA ≤ Iout ≤ 1A		5	20	mV
		LR1117D-3.3V Vin = 4.8V, 10mA ≤ Iout ≤ 1A		6	24	mV
		LR1117D-5.0V Vin = 6.5V, 10mA ≤ Iout ≤ 1A		9	36	mV

ELECTRICAL CHARACTERISTICS continued

T_j=25°C

Symbol	Parameter	Conditions	Min	Typ	Max	Unit
Vdrop	Dropout Voltage	I _{out} =100mA		1.15	1.4	V
		I _{out} =1A		1.2	1.4	V
Ilimit	Current Limit	V _{in} -V _{out} =1.5V, T _j =25°C	1	1.5		A
SVR	Supply Voltage Rejection	f = 120Hz, V _{IN} - V _{OUT} = 3V + 1VPP Ripple	60			dB
Imin	Minimum Load Current	LR1117D-ADJ		2	7	mA
Iq	Quiescent Current	LR1117D-1.2V, V _{in} =10V	1	2	5	mA
		LR1117-1.5V, V _{in} =11V	1	2	5	mA
		LR1117D-1.8V, V _{in} =11V	1	2	5	mA
		LR1117-1.5V, V _{in} =11V	1	2	5	mA
		LR1117D-2.5V, V _{in} =12V	1	2	5	mA
		LR1117D-2.85V, V _{in} =12V	1	2	5	mA
		LR1117D-3.3V, V _{in} =12V	1	2	5	mA
		LR1117D-5.0V, V _{in} =12V	1	2	5	mA
IAdj	Adjust Pin Current	1.5V ≤ V _{IN} - V _{OUT} ≤ 10V I _{LOAD} =10 mA		35	60	uA
ΔV/ΔT	Temperature coefficient			±100		ppm
θ _{JC}	Thermal Resistance	SOT-223		20		°C/W
		TO-252		10		°C/W
θ _{JA}	Thermal Resistance Junction-to-Ambient (No air flow)	SOT-223 (No heat sink)		136		°C/W
		TO-252 (No heat sink)		92		°C/W

Note1: All test are conducted under ambient temperature 25°C and within a short period of time 20ms

Note2: Load current smaller than minimum load current of LR1117D-ADJ will lead to unstable or oscillation output.

BLOCK DIAGRAM

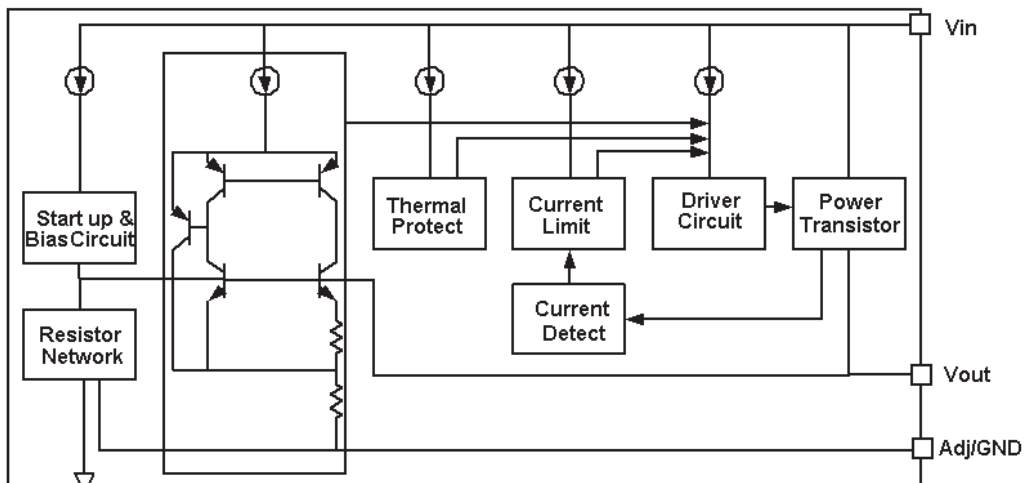

DETAILED DESCRIPTION

LR1117D is a series of low dropout voltage, three terminal regulators. Its application circuit is very simple: the fixed version only needs two capacitors and the adjustable version only needs two resistors and two capacitors to work. It is composed of some modules including start-up circuit, bias circuit, bandgap, thermal shutdown, power transistors and its driver circuit and so on.

The thermal shut down modules can assure chip and its application system working safety when the junction temperature is larger than 140°C.

The bandgap module provides stable reference voltage, whose temperature coefficient is compensated by careful design considerations. The temperature coefficient is under 100 ppm/°C. And the accuracy of output voltage is guaranteed by trimming technique.

TYPICAL APPLICATION

LR1117D has an adjustable version and six fixed versions (1.2V, 1.5V, 1.8V, 2.5V, 2.85V, 3.3V, 5V)

Fixed Output Voltage Version

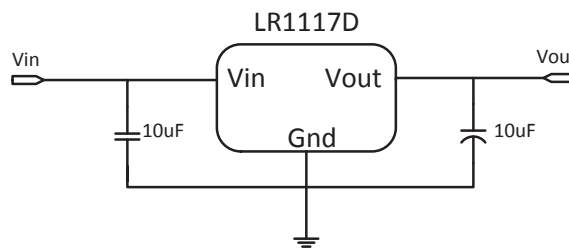

Application circuit of LR1117D fixed version

- 1) Recommend using 10uF tan capacitor or MLCC capacitor as bypass capacitor (C1) for all application circuit.
- 2) Recommend using 10uF tan capacitor MLCC capacitor to assure circuit stability.
- 3) Capacitor ESR range: $3m\Omega \sim 22\Omega$

Adjustable Output Voltage Version

LR1117D-ADJ provides a 1.25V reference voltage. Any output voltage between 1.25V~12V can be achievable by choosing two external resistors (schematic is shown below), R1 and R2

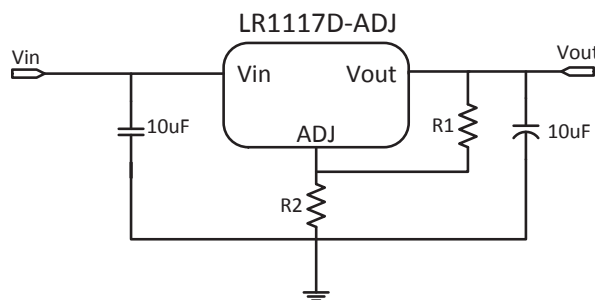

Application Circuit of LR1117D-ADJ

The output voltage of adjustable version follows the equation: $V_{out} = 1.25 \times (1 + R2/R1) + I_{Adj} \times R2$. We can ignore I_{Adj} because I_{Adj} (about 50uA) is much less than the current of R1 (about 2~10mA).

- 1) To meet the minimum load current (>10mA) requirement, R1 is recommended to be 125ohm or lower. As LR1117D-ADJ can keep itself stable at load current about 2mA, R1 is not allowed to be higher than 625ohm.
- 2) Using a bypass capacitor (C_{ADJ}) between the ADJ pin and ground can improve ripple rejection. This bypass capacitor prevents ripple from being amplified as the output voltage is increased. The impedance of C_{ADJ} should be less than R1 to prevent ripple from being amplified. As R1 is normally in the range of $100\Omega \sim 500\Omega$, the value of C_{ADJ} should satisfy this equation: $1/(2\pi \times f_{ripple} \times C_{ADJ}) < R1$.

THERMAL CONSIDERATIONS

We have to take heat dissipation into great consideration when output current or differential voltage of input and output voltage is large. Because in such cases, the power dissipation consumed by LR1117D is very large. LR1117D series uses SOT-223 package type and its thermal resistance is about 20°C/W. And the copper area of application board can affect the total thermal resistance. If copper area is 5cm*5cm (two sides), the resistance is about 30°C/W. So the total thermal resistance is about 20°C/W + 30°C/W. We can decrease total thermal resistance by increasing copper area in application board. When there is no good heat dissipation copper are in PCB, the total thermal resistance will be as high as 120°C/W, then the power dissipation of LR1117D could allow on itself is less than 1W. And furthermore, LR1117D will work at junction temperature higher than 125°C under such condition and no lifetime is guaranteed.

TYPICAL PERFORMANCE CHARACTERISTICS

$T=25^{\circ}\text{C}$ unless specified.

Line Regulation

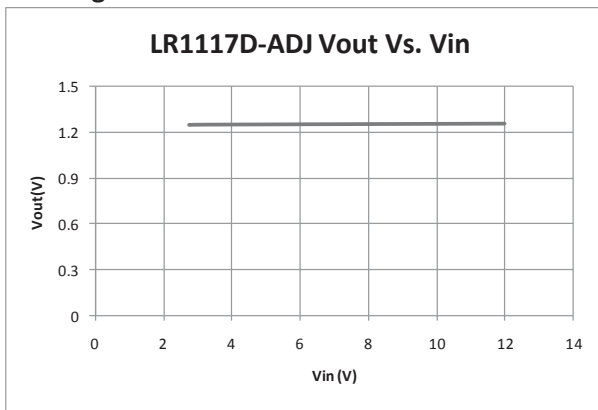

Load Regulation

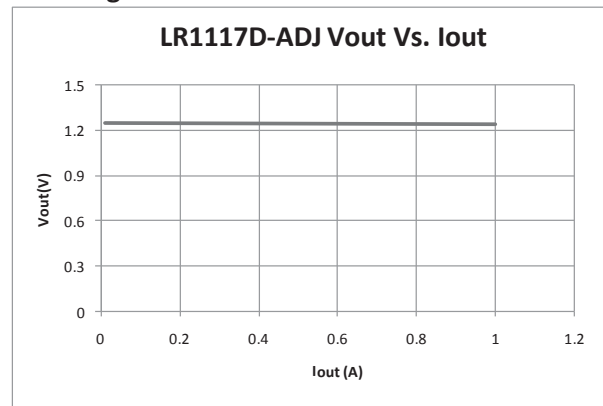

Dropout Voltage

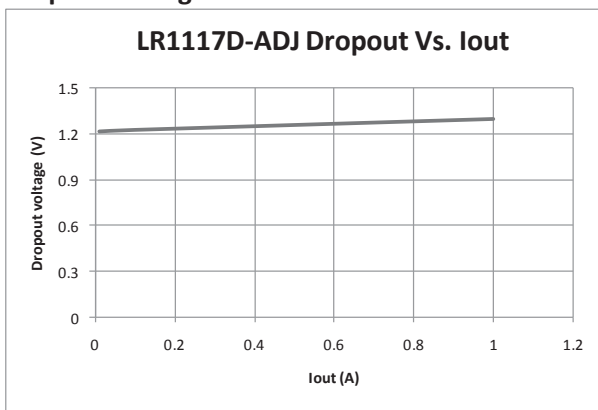

Thermal performance with OTP

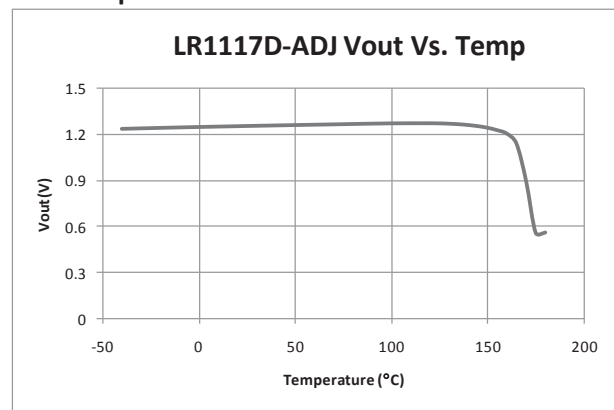

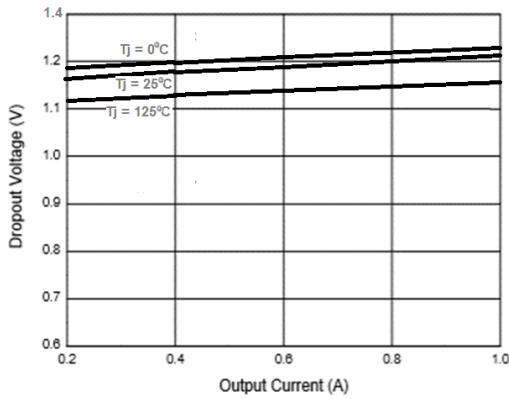
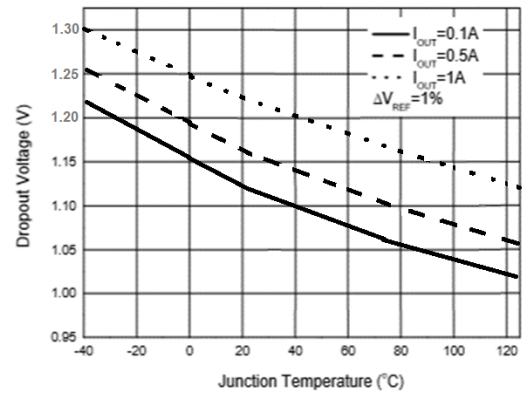
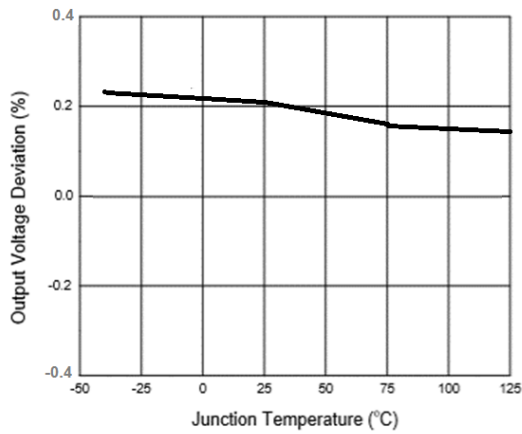
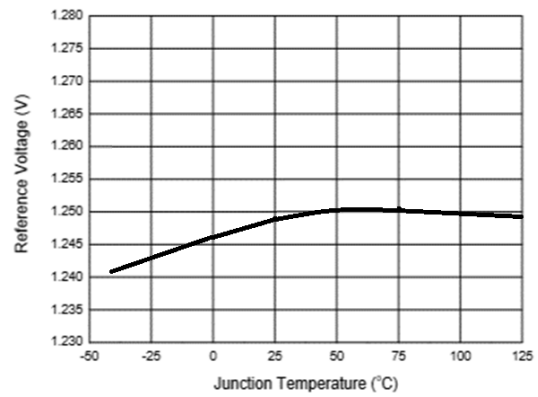
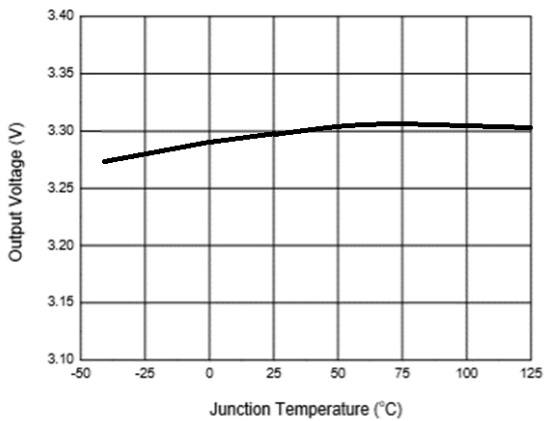
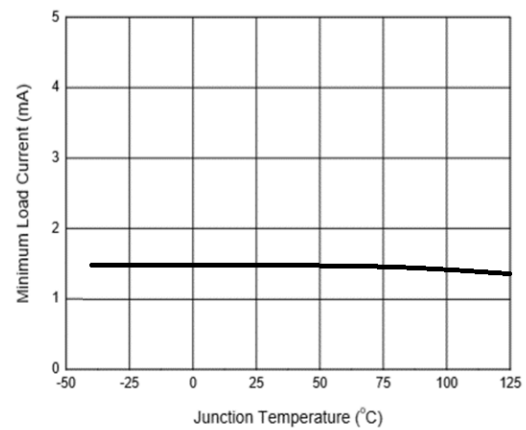
Dropout Voltage vs. Output Current

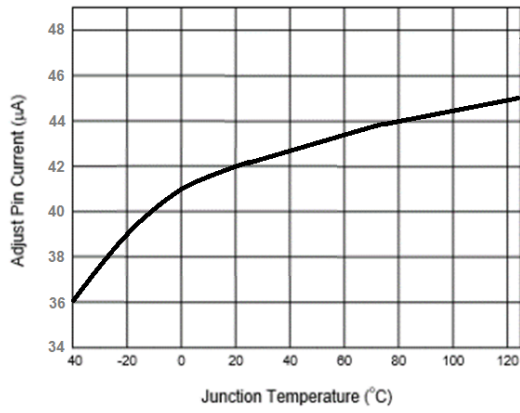
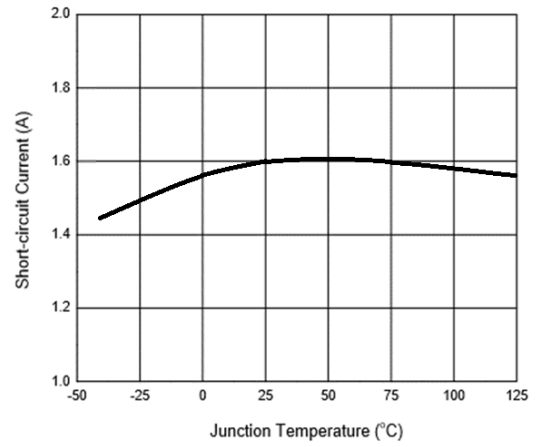
Dropout Voltage vs. Junction Temperature

Load Regulation vs. Junction Temperature
1117MMK (Adj)

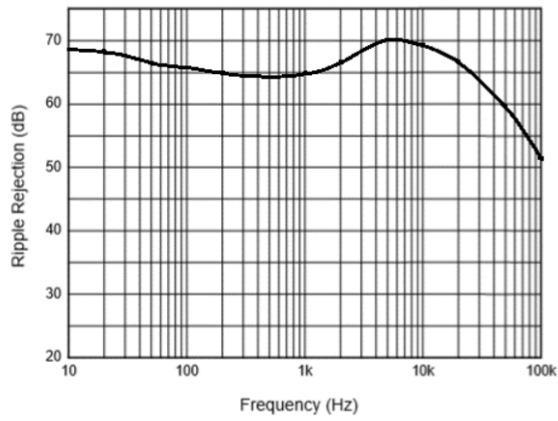
Reference Voltage vs. Junction Temperature

Output Voltage vs. Junction Temperature
1117MMK-3.3

Minimum Load Current vs. Junction Temperature

Adjust Pin Current vs. Junction Temperature

Short-circuit Current vs. Junction Temperature

Ripple Rejection vs. Frequency

$V_{in}=V_{out}+2.5\text{ V}$, $I_{out}=100\text{mA}$, $C_{out}=10\mu\text{F}$

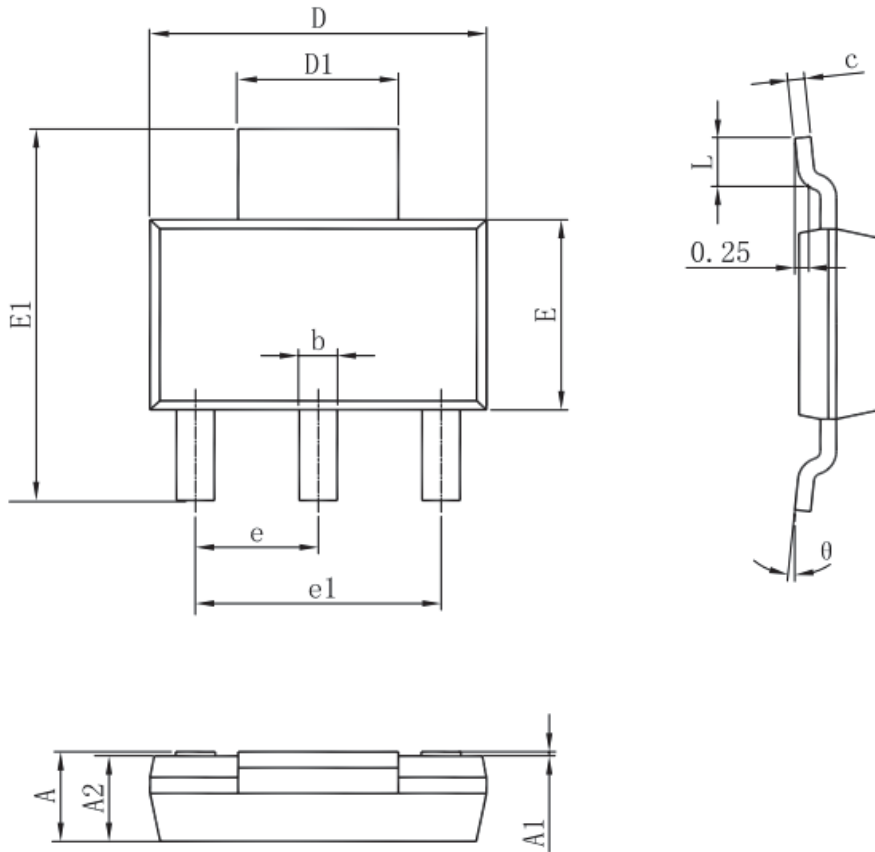

PACKAGE OUTLINE

SOT-223 PACKAGE OUTLINE DIMENSIONS

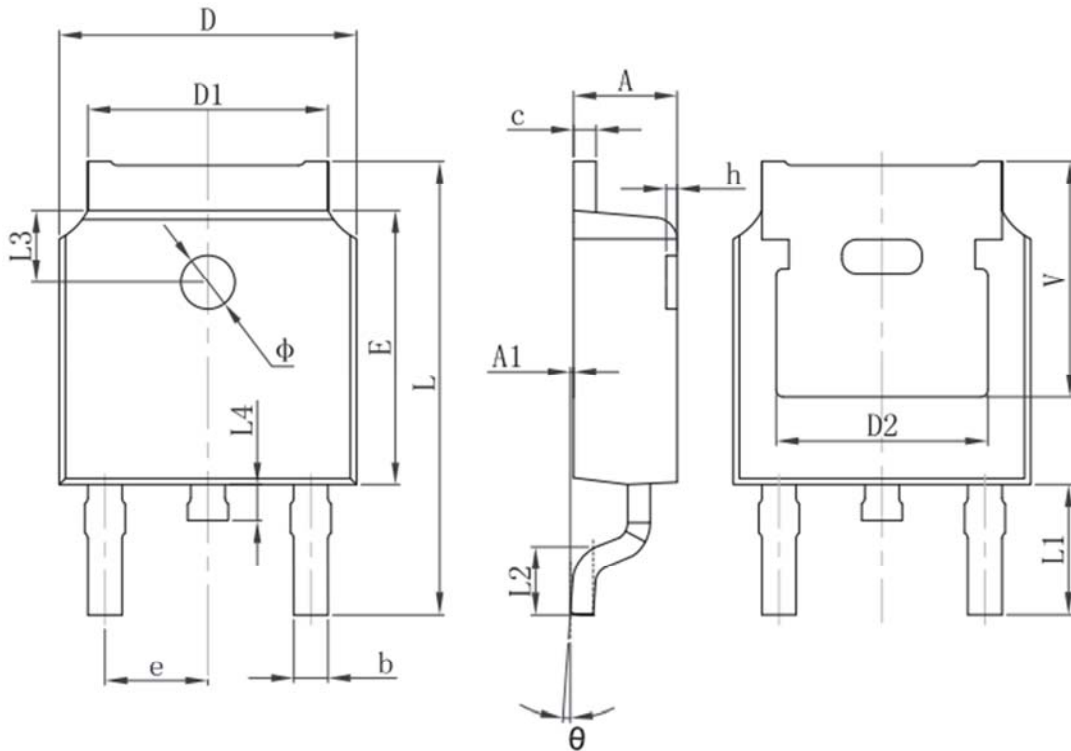

Symbol	Dimensions In Millimeters		Dimensions In Inches	
	Min	Max	Min	Max
A	1.520	1.800	0.060	0.071
A1	0.000	0.100	0.000	0.004
A2	1.500	1.700	0.059	0.067
b	0.660	0.820	0.026	0.032
c	0.250	0.350	0.010	0.014
D	6.200	6.400	0.244	0.252
D1	2.900	3.100	0.114	0.122
E	3.300	3.700	0.130	0.146
E1	6.830	7.070	0.269	0.278
e	2.300(BSC)		0.091(BSC)	
e1	4.500	4.700	0.177	0.185
L	0.900	1.150	0.035	0.045
θ	0°	10°	0°	10°

TO-252-2L PACKAGE OUTLINE DIMENSIONS

Symbol	Dimensions In Millimeters		Dimensions In Inches	
	Min.	Max.	Min.	Max.
A	2.200	2.400	0.087	0.094
A1	0.000	0.127	0.000	0.005
b	0.660	0.860	0.026	0.034
c	0.460	0.580	0.018	0.023
D	6.500	6.700	0.256	0.264
D1	5.100	5.460	0.201	0.215
D2	4.830 REF.		0.190 REF.	
E	6.000	6.200	0.236	0.244
e	2.186	2.386	0.086	0.094
L	9.800	10.400	0.386	0.409
L1	2.900 REF.		0.114 REF.	
L2	1.400	1.700	0.055	0.067
L3	1.600 REF.		0.063 REF.	
L4	0.600	1.000	0.024	0.039
φ	1.100	1.300	0.043	0.051
θ	0°	8°	0°	8°
h	0.000	0.300	0.000	0.012
V	5.350 REF.		0.211 REF.	

Disclaimer

The product information and the selection guides facilitate the selection of LRC's best suited devices for application in your product(s) as per your requirement. It is recommended that you completely review our Data Sheet(s) so as to confirm that the Device(s) meet the performance parameters for your application. The information furnished on LRC's Website, due to the constraint of time and certain conditions, may not be updated timely and is only for customer's reference. Therefore, LRC does not assume responsibility arising from inaccuracies or incomplete information. If necessary, customer is requested to contact LRC's service support for confirmation and accurate information. Furthermore, LRC does not assume liability whatsoever, arising out of the improper application or use of any LRC product; neither does it convey any license under its patent rights nor rights of other intellectual properties. LRC strives for continuous improvement and reserves the right to change the specifications of its products without prior notice.



No. 287 West People Road, Leshan, Sichuan, China.

Telephone: + 86-833-2150227 Fax: + 86-833-2150003

E-mail: market@lrc.cn Website: www.lrc.cn