

# LBSS4350SY3T1G

## S-LBSS4350SY3T1G

### NPN TRANSISTOR

#### 1. FEATURES

- Low collector-to-emitter saturation voltage.
- Fast switching speed.
- Large current capacity and wide ASO.
- We declare that the material of product compliance with RoHS requirements and Halogen Free.
- S- prefix for automotive and other applications requiring unique site and control change requirements; AEC-Q101 qualified and PPAP capable.

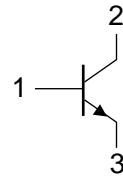
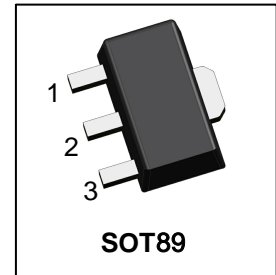

#### 2. DEVICE MARKING AND ORDERING INFORMATION

Device	Marking	Shipping
LBSS4350SY3T1G	A3	1000/Tape&Reel

#### 3. MAXIMUM RATINGS(Ta = 25°C)

Parameter	Symbol	Limits	Unit
Collector–Emitter Voltage	VCEO	50	V
Collector–Base Voltage	VCBO	60	V
Emitter–Base Voltage	VEBO	6	V
Collector Current	IC	3	A
Collector Current(Pulse)	ICP	6	A

#### 4. THERMAL CHARACTERISTICS

Parameter	Symbol	Limits	Unit
Total Device Dissipation, FR-4 Board (Note 1) @ TA = 25°C Derate above 25°C	PD	550 4.4	mW mW/°C
Thermal Resistance, Junction–to–Ambient	RθJA	225	°C/W
Junction and Storage temperature	TJ,Tstg	-55~+150	°C

1.PCB Size:30.0mm×25.0mm×1.6mm,FR-4 Board;

**5. ELECTRICAL CHARACTERISTICS (Ta= 25°C)**

Characteristic		Symbol	Min.	Typ.	Max.	Unit
Collector Cutoff Current (VCB =40V, IE =0 )		ICBO	-	-	1	μA
Emitter Cut-off Current (VEB =4V, IC =0)		IEBO	-	-	1	μA
DC Current Gain (VCE =2V, IC =100mA) (VCE =2V, IC =3A)		HFE	200 35	- -	500 -	
Collector–Emitter Saturation Voltage (IC =2A, IB =100mA)		VCE(sat)	-	0.19	0.5	V
Base–Emitter Saturation Voltage (IC =2A, IB =100mA)		VBE(sat)	-	0.94	1.2	V
Transition Frequency (VCE =10V, IC =50mA, f=100MHz)		fT	-	148	-	MHz
Output Capacitance (VCB = 10 V, f = 1.0 MHz, IE=0)		Cob	-	15	-	pF
Delay Time	(VCC=15V,VBE=-2V, IC=1A,IB1=0.1A)	td	-	10	-	ns
Rise Time		tr	-	9	-	
Storage Time	(VCC=15V,IC=1A, IB1=IB2=0.1A)	ts	-	439	-	
Fall Time		tf	-	73	-	

6.ELECTRICAL CHARACTERISTICS CURVES

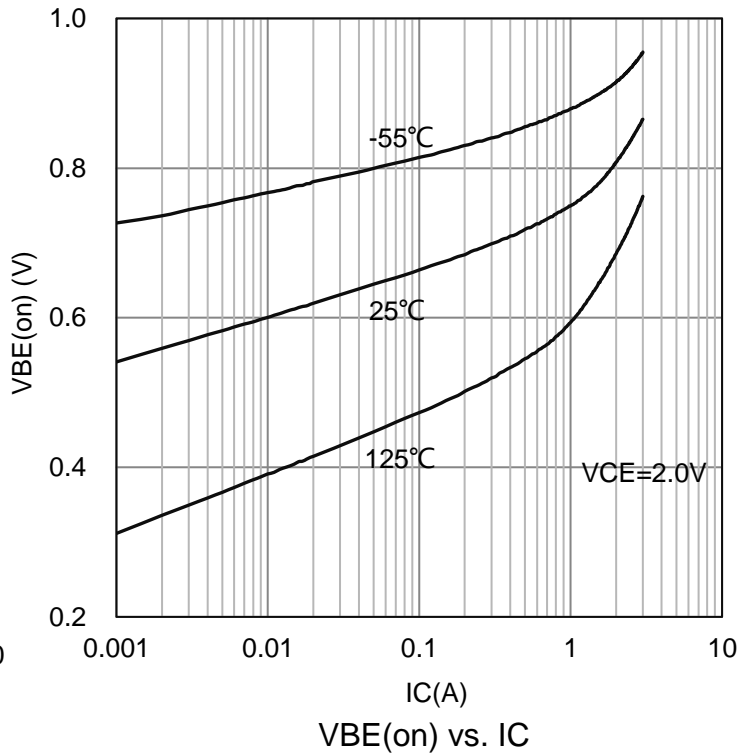
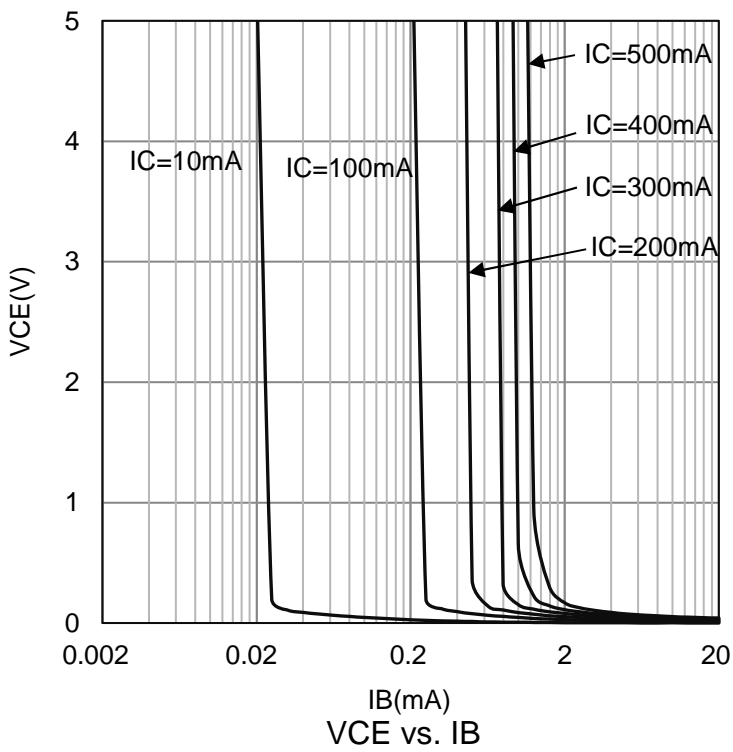
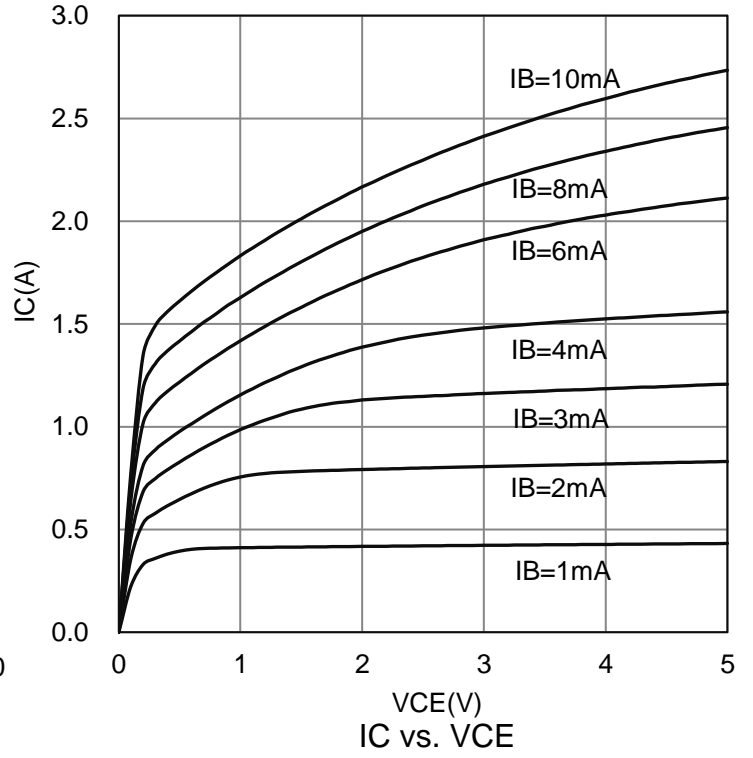
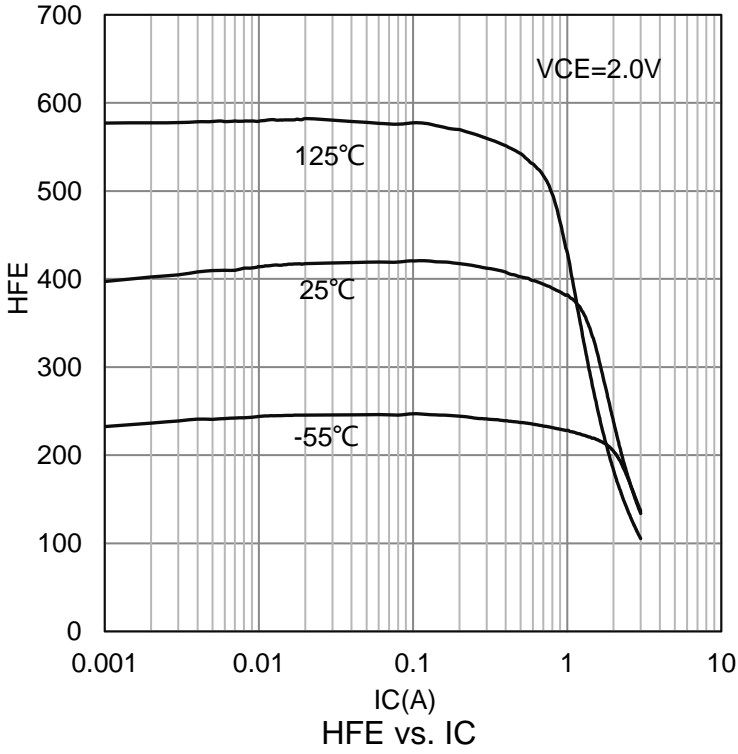

6.ELECTRICAL CHARACTERISTICS CURVES(Con.)

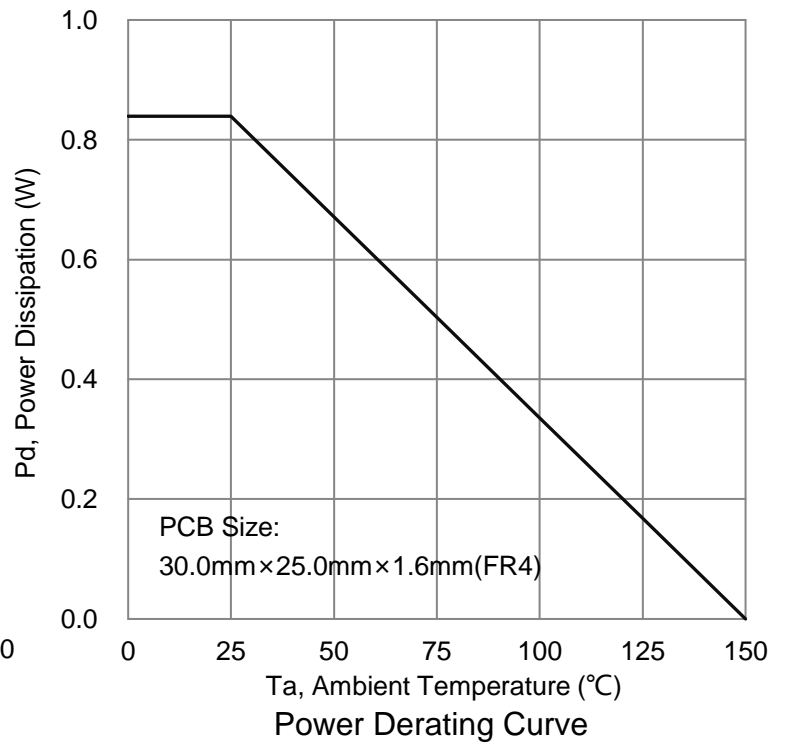
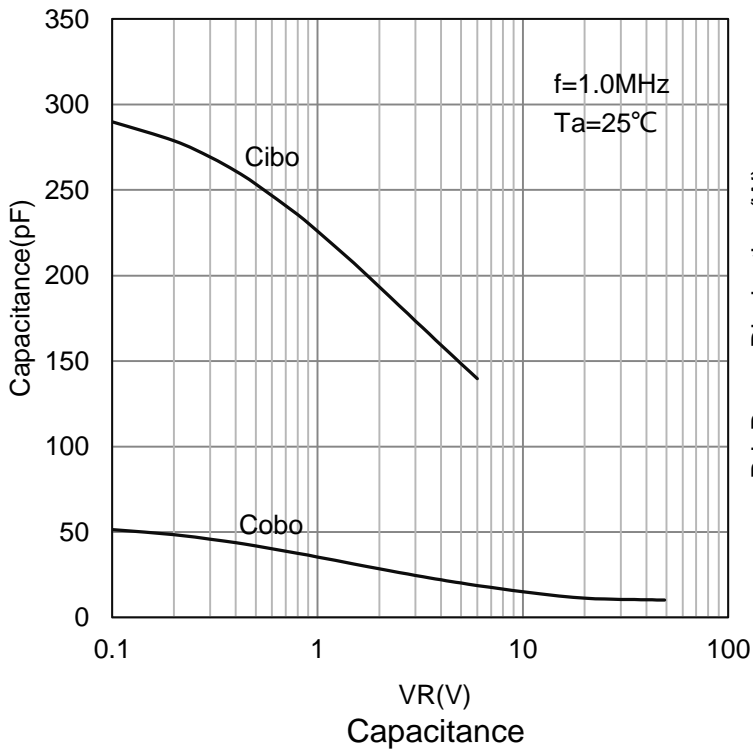
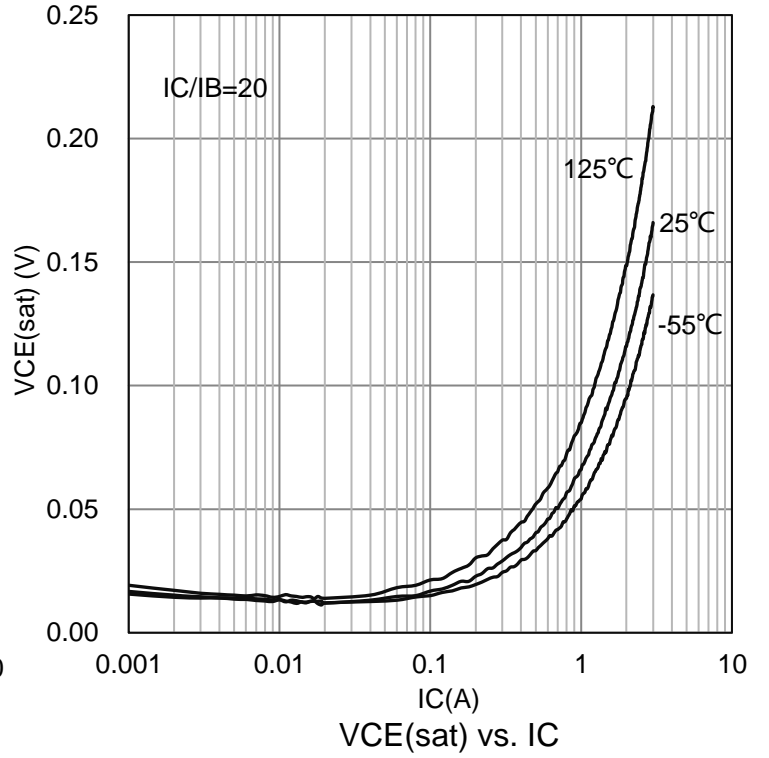
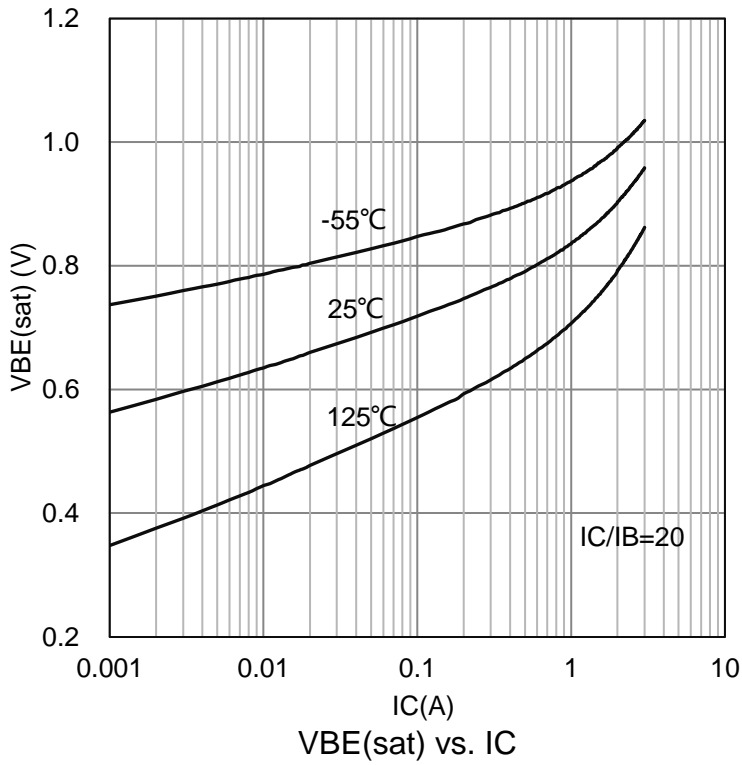

### 7.OUTLINE AND DIMENSIONS

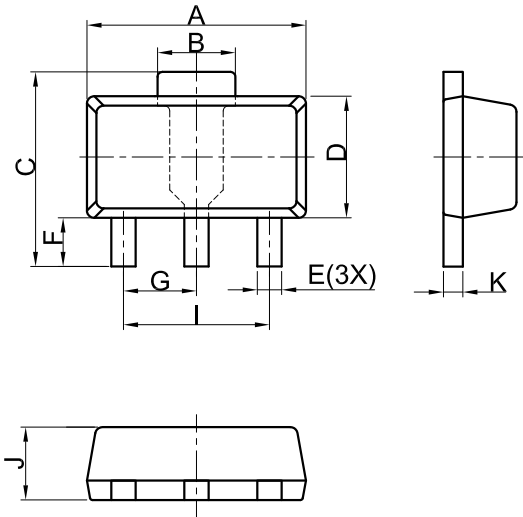

SOT89			
DIM	MIN	NOR	MAX
A	4.30	4.50	4.70
B	1.40	1.60	1.80
C	3.90	4.00	4.25
D	2.30	2.50	2.70
E	0.40	0.50	0.58
F	0.90	1.00	1.20
G	1.50 BSC		
I	3.00 BSC		
J	1.40	1.50	1.60
K	0.34	0.40	0.50
All Dimensions in mm			

#### GENERAL NOTES

1. Top package surface finish Ra0.4±0.2um
2. Bottom package surface finish Ra0.7±0.2um
3. Side package surface finish Ra0.4±0.2um
4. Protrusion or Gate Burrs shall not exceed 0.10mm per side.

### 8.SOLDERING FOOTPRINT

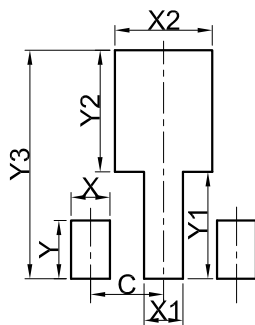

SOT89	
DIM	(mm)
X	0.80
Y	1.20
X1	0.80
Y1	2.20
X2	2.00
Y2	2.50
C	1.50
Y3	4.70

## **DISCLAIMER**

- Curve guarantee in the specification. The curve of test items with electric parameter is used as quality guarantee. The curve of test items without electric parameter is used as reference only.
- Before you use our Products for new Project, you are requested to carefully read this document and fully understand its contents. LRC shall not be in any way responsible or liable for failure, malfunction or accident arising from the use of any LRC's Products against warning, caution or note contained in this document.
- All information contained in this document is current as of the issuing date and subject to change without any prior notice. Before purchasing or using LRC's Products, please confirm the latest information with a LRC sales representative.